

JEE PHYSICS

- ▶ Specially designed eBook for complete JEE syllabus
- ▶ JEE preparation strategy & direction, speedy revision
- ▶ Chapter-wise important Problem-Solving
- ▶ Theory, Formulas & Diagrams to crack JEE
- ▶ Detailed high quality video lectures by experienced faculties
- ▶ JEE full preparation for Class XI & XII



misostudy
connect smart learning

JEE·NEET·AIIMS·CBSE·FOUNDATION
www.misostudy.com

☎ 8929803804 (MON-FRI: 9am-6pm) support@misostudy.com

MISO STUDY INDIA PVT. LTD.
2ND FLOOR 65-A, OMPRO TOWER, KALU SARAI, NEW DELHI, DELHI 110016

Class 11 | Physics

01 Units and Measurement

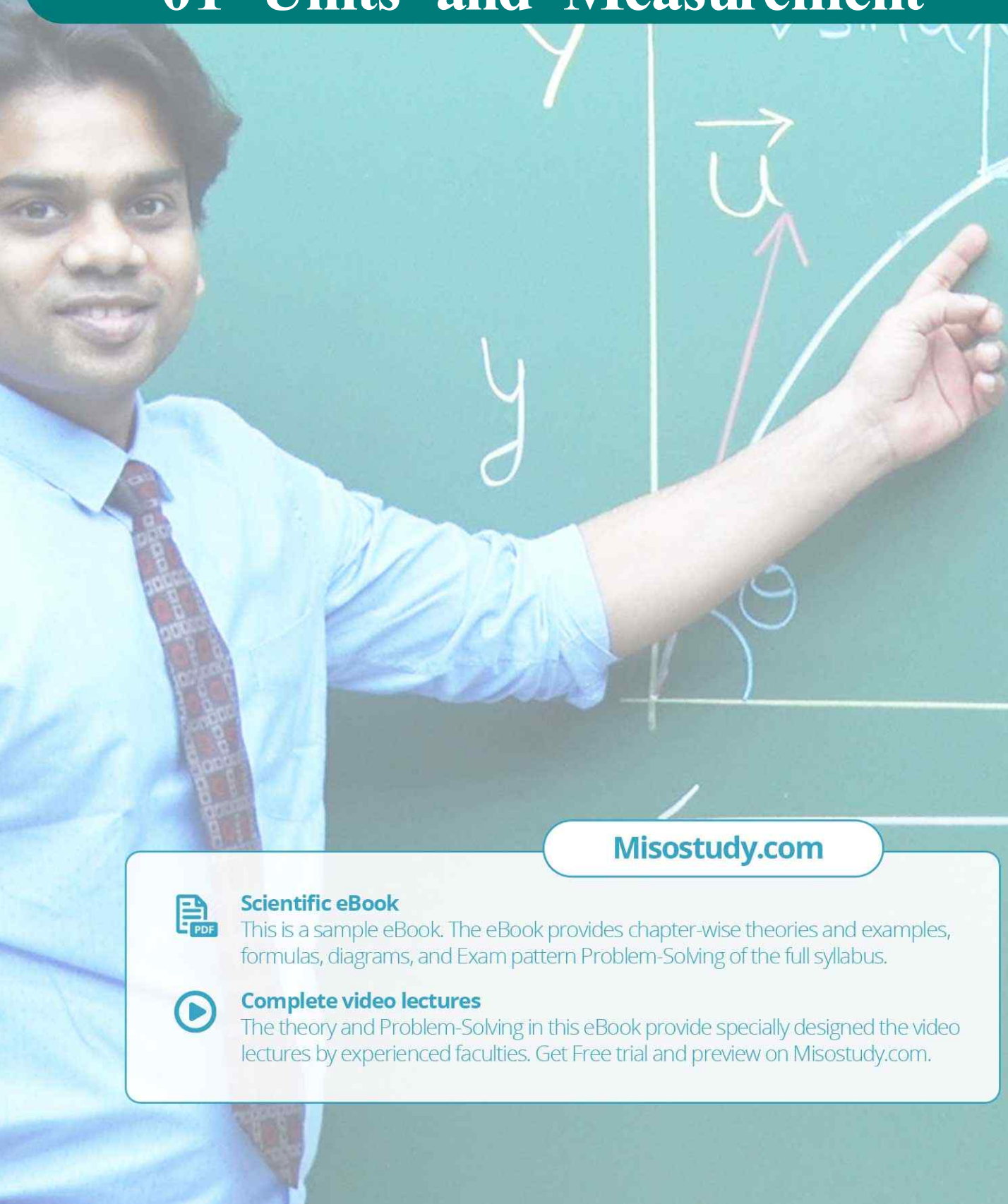

Misostudy.com



Scientific eBook

This is a sample eBook. The eBook provides chapter-wise theories and examples, formulas, diagrams, and Exam pattern Problem-Solving of the full syllabus.



Complete video lectures

The theory and Problem-Solving in this eBook provide specially designed the video lectures by experienced faculties. Get Free trial and preview on Misostudy.com.

01. Physical Quantities

All the quantities which are used to describe the laws of physics are known as *physical quantities*.

Classification : Physical quantities can be classified on the following bases :

(A) Based on their directional properties

I. Scalars : The physical quantities which have only magnitude but no direction are called *scalar quantities*.

e.g. mass, density, volume, time, etc.

II. Vectors : The physical quantities which both magnitude and direction and obey laws of vector algebra are called *vector quantities*.

e.g. displacement, force, velocity, etc.

(B) Based on their dependency

I. Fundamental or base quantities : The quantities which do not depend upon other quantities for their complete definition are known as *fundamental or base quantities*.

e.g. length, mass, time, etc.

II. Derived quantities : The quantities which can be expressed in terms of the fundamental quantities are known as *derived quantities*.

e.g. Speed (=distance/time), volume, acceleration, force, pressure, etc.

Example

Classify the quantities displacement, mass, force, time, speed, velocity, acceleration, pressure and work under the following categories:

- base and scalar
- base and vector
- derived and scalar
- derived and vector

Solution

- mass, time
- displacement
- speed, pressure, work
- force, velocity, acceleration

02. Units of Physical Quantities

The chosen reference standard of measurement in multiples of which, a physical quantity is expressed is called the *unit* of that quantity.

System of Units

- FPS or British Engineering system** : In this system length, mass and time are taken as fundamental quantities and their base units are foot (ft), pound (lb) and second (s) respectively.
- CGS or Gaussian system** : In this system the fundamental quantities are length, mass and time and their respective units are centimeter (cm), gram (g) and second (s).
- MKS system** : In this system also the fundamental quantities are length, mass and time but their fundamental units are metre (m), kilogram (kg) and second (s) respectively.

- (iv) **International system (SI) of units** : This system is modification over the MKS system and so it is also known as *Rationalised MKS* system. Besides the three base units of MKS system four fundamental and two supplementary units are also included in this system.

SI BASE QUANTITIES AND THEIR UNITS			
S. No.	Physical quantity	Unit	Symbol
1	Length	metre	m
2	Mass	kilogram	kg
3	Time	second	s
4	Temperature	kelvin	K
5	Electric current	ampere	A
6	Luminous intensity	candela	cd
7	Amount of substance	mole	mol

03. Classification of Units

The units of physical quantities can be classified as follows :

(i) **Fundamental or base units**

The units of fundamental quantities are called *base units*. In SI there are seven base units.

(ii) **Derived units**

The units of derived quantities or the units that can be expressed in terms of the base units are called *derived units*.

$$\text{e.g. unit of speed} = \frac{\text{unit of distance}}{\text{unit of time}} = \frac{\text{metre}}{\text{second}} = \text{m/s}$$

Some derived units are named in honour of great scientists.

e.g. unit of force – newton (N), unit of frequency – hertz (Hz), etc.

(iii) **Supplementary units**

In International System (SI) of units two *supplementary units* are also defined viz. radian (rad) for plane angle and steradian (sr) for solid angle.

- **radian** : 1 radian is the angle subtended at the centre of a circle by an arc equal in length to the radius of the circle.
- **steradian** : 1 steradian is the solid angle subtended at the centre of a sphere, by the surface of the sphere which is equal in area to the square of the radius of the sphere.

(iv) **Practical units**

Due to the fixed sizes of SI units, some *practical units* are also defined for both fundamental and derived quantities. e.g. light year (ly) is a practical unit of distance (a fundamental quantity) and horse power (hp) is a practical unit of power (a derived quantity).

Practical units may or may not belong to a particular system of units but can be expressed in any system of units.

$$\text{e.g. } 1 \text{ mile} = 1.6 \text{ km} = 1.6 \times 10^3 \text{ m} = 1.6 \times 10^5 \text{ cm.}$$

01 Units and Measurement

Conversion factors

To convert a physical quantity from one set of units to the other, the required multiplication factor is called *conversion factor*.

Magnitude of a physical quantity = numeric value (n) × unit (u)

While conversion from one set of units to the other the magnitude of the quantity must remain same. Therefore

$$n_1 u_1 = n_2 u_2 \quad \text{or} \quad n u = \text{constant} \quad \text{or} \quad n \propto \frac{1}{u}$$

This is the numeric value of a physical quantity is inversely proportional to the base unit.

e.g. $1\text{m} = 100\text{ cm} = 3.28\text{ ft} = 39.4\text{ inch}$
(SI) (CGS) (FPS)

Example The acceleration due to gravity is 9.8 m s^{-2} . Given its value in ft s^{-2}

Solution As $1\text{m} = 3.2\text{ ft}$

$$\therefore 9.8\text{ m/s}^2 = 9.8 \times 3.28\text{ ft/s}^2 = 32.14\text{ ft/s}^2 \approx 32\text{ ft/s}^2$$

04. Dimensions

Dimensions of a physical quantity are the powers for exponents to which the base quantities are raised to represent that quantity.

Dimensional formula

The dimensional formula of any physical quantity is that expression which represents how and which of the base quantities are included in that quantity.

It is written by enclosing the symbols for base quantities with appropriate powers in square brackets i.e. []

e. g. Dimensional formula of mass in $[M^1 L^0 T^0]$ is the dimensional formula of the force and the dimensions of force are 1 in mass, 1 in length and -2 in time

05. Applications of Dimensional Analysis

(i) To convert a physical quantity from one system of units to the other :

This is based on a fact that magnitude of a physical quantity remains same whatever system is used for measurement i.e. magnitude = numeric value (n) × unit (u) = constant

$$\text{or } n_1 u_1 = n_2 u_2$$

So if a quantity is represented by $[M^a L^b T^c]$

$$\text{Then } n_2 = n_1 \left(\frac{u_1}{u_2} \right) = n_1 \left(\frac{M_1}{M_2} \right)^a \left(\frac{L_1}{L_2} \right)^b \left(\frac{T_1}{T_2} \right)^c$$

Here n_2 = numerical value in II system
 n_1 = numerical value in I system
 M_1 = unit of mass in I system
 M_2 = unit of mass in II system
 L_1 = unit of length in I system
 L_2 = unit of length in II system
 T_1 = unit of time in I system
 T_2 = unit of time in II system

Example

Convert 1 newton (SI unit of force) into dyne (CGS unit of force)

Solution

The dimensional equation of force is $[F] = [M^1 L^1 T^{-2}]$

Therefore if $n_1, u_1,$ and $n_2, u_2,$ corresponds to SI & CGS units respectively, then

$$n_2 = n_1 \left[\frac{M_1}{M_2} \right]^1 \left[\frac{L_1}{L_2} \right]^1 \left[\frac{T_1}{T_2} \right]^{-2} = 1 \left[\frac{\text{kg}}{\text{g}} \right] \left[\frac{\text{m}}{\text{cm}} \right] \left[\frac{\text{s}}{\text{s}} \right]^{-2} = 1 \times 1000 \times 100 \times 1 = 10^5 \therefore$$

1 newton = 10^5 dyne.

(ii) To check the dimensional correctness of a given physical relation

If in a given relation, the terms on both the sides have the same dimensions, then the relation is dimensionally correct. This is known as the principle of homogeneity of dimensions.

Example

Check the accuracy of the relation $T = 2\pi \sqrt{\frac{L}{g}}$ for a simple pendulum using

Solution

The dimensions of LHS = the dimension of $T = [M^0 L^0 T^1]$

The dimensions of RHS = $\left(\frac{\text{dimensions of length}}{\text{dimensions of acceleration}} \right)^{1/2}$ ($\because 2\pi$ is a dimensionless constant)

$$= \left[\frac{L}{LT^{-2}} \right]^{1/2} = [T^2]^{1/2} = [T] = [M^0 L^0 T^1]$$

Since the dimensions are same on both the sides, the relation is correct.

(iii) To derive relationship between different physical quantities

Using the same principle of homogeneity of dimensions new relations among physical quantities can be derived if the dependent quantities are known.

Example

It is known that the time of revolution T of a satellite around the earth depends on the universal gravitational constant G , the mass of the earth M , and the radius of the circular orbit R . Obtain an expression for T using dimensional analysis.

We have $[T] = [G]^a [M]^b [R]^c$

Solution

$$[M]^0 [L]^0 [T]^1 = [M]^{-a} [L]^{3a} [T]^{-2a} \times [M]^b \times [L]^c = [M]^{b-a} [L]^{c+3a} [T]^{-2a}$$

Comparing the exponents

$$\text{For } [T]: 1 = -2a \Rightarrow a = -\frac{1}{2} \quad \text{For } [M]: 0 = b - a \Rightarrow b = a = -\frac{1}{2}$$

$$\text{For } [L]: 0 = c + 3a \Rightarrow c = -3a = \frac{3}{2}$$

Putting the values we get $T \propto G^{-1/2} M^{-1/2} R^{3/2} \Rightarrow T \propto \sqrt{\frac{R^3}{GM}}$

The actual expression is $T = 2\pi \sqrt{\frac{R^3}{GM}}$

Dimensions of trigonometric, exponential, logarithmic function etc.

All trigonometric, exponential and logarithmic functions and their arguments are dimensionless.

NOTE  Trigonometric function $\sin\theta$ and its argument θ are dimensionless.

06. Limitations of this Method

- In Mechanics the formula for a physical quantity depending one more than three physical quantities cannot be derived. It can only be checked.
- This method can be used only if the dependency is of multiplication type. The formulae containing exponential, trigonometrical and logarithmic functions can't be derived using this method. Formulae containing more than one term which are added or subtracted like $s = ut + at^2/2$ also can't be derived.
- The relation derived from this method gives no information about the dimensionless constants.
- If dimensions are given, physical quantity may not be unique as many physical quantities have the same dimensions.
- It gives no information whether a physical quantity is a scalar or a vector.

07. Significant Figures or Digits

The significant figure (SF) in a measurement are the figure or digits that are known with certainty plus one that is uncertain.

Significant figures in a measured value of a physical quantity tell the number of digits in which we have confidence. Larger the number of significant figure obtained in a measurement, greater is its accuracy and vice versa.

Rules to find out the number of significant figures

- I Rule** : All the non-zero digits are significant e.g. 1984 has 4 SF.
- II Rule** : All the zeros between two non-zero digits are significant. e.g. 10806 has 5 SF
- III Rule** : All the zeros to the left of first non-zero digit are not significant. e.g. 00108 has 3 SF.
- IV Rule** : If the number is less than 1, zeros on the right of the decimal point but to the left of the first non-zero digit are not significant. e.g. 0.002308 has 4 SF.
- V Rule** : The trailing zeros (zeros to the right of the last non-zero digit) in a number with a decimal point are significant. e.g. 01.080 has 4 SF.

VI Rule : The trailing zeros in a number without a decimal point are not significant e.g. 010100 has 3 SF. But if the number comes from some actual measurement then the trailing zeros become significant. e.g. $m = 100$ kg has 3 SF.

VII Rule : When the number is expressed in exponential form, the exponential term does not affect the number of S.F. For example in $x = 12.3 = 1.23 \times 10^1 = 0.123 \times 10^2 = 0.0123 \times 10^3 = 123 \times 10^{-1}$ each term has 3 SF only.

Rules for arithmetical operations with significant figures

I Rule : In addition or subtraction the number of decimal places in the result should be equal to the number of decimal places of that term in the operation which contain lesser number of decimal places. e.g. $12.587 - 12.5 = 0.087 = 0.1$ (\because second term contain lesser i.e. one decimal place)

II Rule : In multiplication or division, the number of SF in the product or quotient is same as the smallest number of SF in any of the factors. e.g. $4.0 \times 0.12 = 0.484 = 0.48$

- To avoid the confusion regarding the trailing zeros of the numbers without the decimal point the best way is to report every measurement in scientific notation (in the power of 10). In this notation every number is expressed in the form $a \times 10^b$, where a is the base number between 1 and 10 and b is any positive or negative exponent of 10. The base number (a) is written in decimal form with the decimal after the first digit. While counting the number of SF only base number is considered (Rule VII).
- The change in the unit of measurement of a quantity does not effect the number of SF. For example in $2.308 \text{ cm} = 23.08 \text{ mm} = 0.02308 \text{ m} = 23080 \text{ }\mu\text{m}$ each term has 4 SF.

Example Write down the number of significant figures in the following.

- 165
- 2.05
- 34.000 m
- 0.005
- 0.02340 N m^{-1}
- 26900
- 26900 kg

Solution

(a) 165	3 SF (following rule I)
(b) 2.05	3 SF (following rule I & II)
(c) 34.000 m	5 SF (following rule I & V)
(d) 0.005	1 SF (following rules I & IV)
(e) 0.02340 N m^{-1}	4 SF (following rule I, IV & V)
(f) 26900	3 SF (see rule VI)
(g) 26900 kg	5 SF (see rule VI)

08. Rounding Off

To represent the result of any computation containing more than one uncertain digit, it is rounded off to appropriate number of significant figures.

Rules for rounding off the numbers :

- I Rule** : If the digit to be rounded off is more than 5, then the preceding digit is increased by one. e.g. $6.87 \approx 6.9$
- II Rule** : If the digit to be rounded off is less than 5, than the preceding digit is unaffected and is left unchanged. e.g. $3.94 \approx 3.9$
- III Rule** : If the digit to be rounded off is 5 than the preceding digit is increased by one if it odd and is left unchanged if it is even. e.g. $14.35 \approx 14.4$ and $14.45 \approx 14.4$

Example

The length, breadth and thickness of a metal sheet are 4.234 m, 1.005 m and 2.01 cm respectively. Give the area and volume of the sheet to correct number of significant figures.

Solution

length (l) = 4.234 m breadth (b) = 1.005 m

thickness (t) = 2.01 cm = 2.01×10^{-2} m

$$\begin{aligned} \text{Therefore area of the sheet} &= 2(l \times b + b \times t + t \times l) \\ &= 2(4.234 \times 1.005 + 1.005 \times 0.0201 + 0.0201 \times \\ &4.234) \text{ m}^2 \\ &= 2(4.3604739) \text{ m}^2 = 8.720978 \text{ m}^2 \end{aligned}$$

Since area can contain a max^m of 3 SF (Rule II of article 4.2) therefore, rounding off, we get

$$\text{Area} = 8.72 \text{ m}^2$$

$$\text{Like wise volume} = l \times b \times t = 4.234 \times 1.005 \times 0.0201 \text{ m}^3 = 0.0855289 \text{ m}^3$$

Since volume can contain 3 SF, therefore, rounding off, we get

$$\text{Volume} = 0.0855 \text{ m}^3$$

09. Order of Magnitude

Order of magnitude of a quantity is the power of 10 required to represent that quantity. This power is determined after rounding off the value of the quantity properly. For rounding off, the last digit is simply ignored if it is less than 5 and, is increased by one if it is 5 or more than 5.

- When a number is divided by 10^x (where x is the order of the number) the result will always lie between 0.5 and 5 i.e. $0.5 \leq N/10^x < 5$

Example Order of magnitude of the following values can be determined as follows :

(a) $49 = 4.9 \times 10^1 \approx 10^1$

Solution \therefore Order of magnitude = 1

(b) $51 = 5.1 \times 10^1 \approx 10^2$

Solution \therefore Order of magnitude = 2

(c) $0.049 = 4.9 \times 10^{-2} \approx 10^{-2}$

Solution \therefore Order of magnitude = -2

(d) $0.050 = 5.0 \times 10^{-2} \approx 10^{-1}$

Solution \therefore Order of magnitude = -1

(e) $0.051 = 5.1 \times 10^{-2} \approx 10^{-1}$

Solution \therefore Order of magnitude = -1

• **Accuracy, Precision of Instruments and Errors in Measurement**

Accuracy and Precision

The result of every measurement by any measuring instrument contains some uncertainty. This uncertainty is called error. Every calculated quantity which is based on measured value, also has an error. Every measurement is limited by the reliability of the measuring instrument and skill of the person making the measurement. If we repeat a particular measurement, we usually do not get precisely the same result as each result is subjected to some experimental error. This imperfection in measurement can be described in terms of accuracy and precision. The accuracy of a measurement is a measure of how close the measured value is to the true value of the quantity. Precision tells us to what resolution or limit the quantity is measured, we can illustrate the difference between accuracy and precision with help of a example. Suppose the true value of a certain length is 1.234 cm. In one experiment, using a measuring instrument of resolution 0.1 cm, the measured value is found to be 1.1cm, while in another experiment using a measuring device of greater resolution of 0.01m, the length is determined to be 1.53cm. The first measurement has more accuracy (as it is closer to the true value) but less precision (as resolution is only 0.1 cm), while the second measurement is less accurate but more precise.

10. Errors

The difference between the true value and the measured value of a quantity is known as the error of measurement.

Errors may arise from different sources and are usually classified as follows

Systematic or Controllable Errors

Systematic errors are the errors whose causes are known. They can be either positive or negative. Due to the known causes these errors can be minimised. Systematic errors can further be classified into three categories

- (i) **Instrumental errors** :- These errors are due to imperfect design or erroneous manufacture or misuse of the measuring instrument. These can be reduced by using more accurate instruments.
- (ii) **Environmental errors** :- These are due to the changes in external environmental conditions such as temperature, pressure, humidity, dust vibrations or magnetic and electrostatic fields.

(iii) **Observational errors** :- These errors arise due to improper setting of the apparatus or carelessness in taking observations.

Random Errors

These errors are due to unknown causes. Therefore they occur irregularly and are variable in magnitude and sign. Since the causes of these errors are not known precisely they can not be eliminated completely. For example, when the same person repeats the same observation in the same conditions, he may get different readings different times.

Random errors can be reduced by repeating the observation a large number of times and taking the arithmetic mean of all the observations. This mean value would be very close to the most accurate reading.

NOTE

If the number of observations is made n times then the random error reduces to $\left(\frac{1}{n}\right)$ times.

Gross Errors : Gross errors arise due to human carelessness and mistakes in reading the instruments or calculating and recording the measurement results.

For example :-

- (i) Reading instrument without proper initial settings.
- (ii) Taking the observations wrongly without taking necessary precautions.
- (iii) Exhibiting mistakes in recording the observations.
- (iv) Putting improper values of the observations in calculations.

These errors can be minimised by increasing the sincerity and alertness of the observer.

11. Representation of Errors

Errors can be expressed in the following ways

Absolute Error (Δa) : The difference between the true value and the individual measured value of the quantity is called the absolute error of the measurement.

Suppose a physical quantity is measured n times and the measured values are $a_1, a_2, a_3, \dots, a_n$. The arithmetic mean (a_m) of these values is

$$a_m = \frac{a_1 + a_2 + a_3 + \dots + a_n}{n} = \frac{1}{n} \sum_{i=1}^n a_i \quad \dots(i)$$

If the true value of the quantity is not given then mean value (a_m) can be taken as the true value. Then the absolute errors in the individual measured values are

$$\Delta a_1 = a_m - a_1$$

$$\Delta a_2 = a_m - a_2$$

.....

.....

$$\Delta a_n = a_m - a_n$$

The arithmetic mean of all the absolute errors is defined as the final or mean absolute error $(\Delta a)_m$ or Δa of the value of the physical quantity a

$$(\Delta a)_m = \frac{|\Delta a_1| + |\Delta a_2| + \dots + |\Delta a_n|}{n} = \frac{1}{n} \sum_{i=1}^n |\Delta a_i| \quad \dots(ii)$$

So if the measured value of a quantity be 'a' and the error in measurement be Δa , then the true value (a_t) can be written as

$$a_t = a \pm \Delta a \quad \dots(\text{iii})$$

Relative or Fractional Error : It is defined as the ratio of the mean absolute error $((\Delta a)_m$ or $\overline{\Delta a}$) to the true value or the mean value (a_m or \bar{a}) of the quantity measured.

$$\text{Relative or fractional error} = \frac{\text{Mean absolute error}}{\text{Mean value}} = \frac{(\Delta a)_m}{a_m} \text{ or } \frac{\overline{\Delta a}}{\bar{a}} \quad \dots(\text{iv})$$

When the relative error is expressed in percentage, it is known as percentage error, percentage error = relative error $\times 100$

$$\text{or percentage error} = \frac{\text{mean absolute error}}{\text{true value}} \times 100\% = \frac{\overline{\Delta a}}{a} \times 100\% \quad \dots(\text{v})$$

12. Propagation of Errors in Mathematical Operations

Rule I : The maximum absolute error in the sum or difference of the two quantities is equal to the sum of the absolute errors in the individual quantities.

If $X = A + B$ or $X = A - B$ and if $\pm \Delta A$ and $\pm \Delta B$ represent the absolute errors in A and B respectively, then the maximum absolute error in $X = \Delta X = \Delta A + \Delta B$ and

$$\text{Maximum percentage error} = \frac{\Delta X}{X} \times 100 \quad \dots(\text{i})$$

The result will be written as $X \pm \Delta X$ (in terms of absolute error)

$$\text{or } X \pm \frac{\Delta X}{X} \times 100\% \text{ (in terms of percentage error)}$$

Rule II : The maximum fractional or relative error in the product or division of quantities is equal to the sum of the fractional or relative errors in the individual quantities.

$$\text{If } X = A \times B \text{ or } X = A/B$$

$$\text{then } \frac{\Delta X}{X} = \pm \left(\frac{\Delta A}{A} + \frac{\Delta B}{B} \right) \quad \dots(\text{ii})$$

Rule III : The maximum fractional error in a quantity raised to a power (n) is n times the fractional error in the quantity itself, i.e.

$$\text{If } X = A^n \text{ then } \frac{\Delta X}{X} = n \left(\frac{\Delta A}{A} \right) \quad \dots(\text{viii})$$

$$\text{If } X = A^p B^q C^r \text{ then } \frac{\Delta X}{X} = \left[p \left(\frac{\Delta A}{A} \right) + q \left(\frac{\Delta B}{B} \right) + r \left(\frac{\Delta C}{C} \right) \right]$$

$$\text{If } X = \frac{A^p B^q}{C^r} \text{ then } \frac{\Delta X}{X} = \left[p \left(\frac{\Delta A}{A} \right) + q \left(\frac{\Delta B}{B} \right) + r \left(\frac{\Delta C}{C} \right) \right]$$

IMPORTANT POINTS

- Systematic errors are repeated consistently with the repetition of the experiment and are produced due to improper conditions or procedures that are consistent in action whereas random errors are accidental and their magnitude and sign cannot be predicated from the knowledge of the measuring system and conditions of measurement. Systematic errors can therefore be minimised by improving experimental techniques, selecting better instruments and improving personal skills whereas random errors can be minimised by repeating the observation several times.
- Mean absolute error has the units and dimensions of the quantity itself whereas fractional or relative error is unitless and dimensionless.
- Absolute errors may be positive in certain cases and negative in other cases.

Example The initial and final temperatures of water as recorded by an observer are $(40.6 \pm 0.2)^\circ\text{C}$ and $(78.3 \pm 0.3)^\circ\text{C}$. Calculate the rise in temperature with proper error limits.

Solution Given $\theta_1 = (40.6 \pm 0.2)^\circ\text{C}$ and $\theta_2 = (78.3 \pm 0.3)^\circ\text{C}$
 Rise in temp. $\theta = \theta_2 - \theta_1 = 78.3 - 40.6 = 37.7^\circ\text{C}$.
 $\Delta\theta = \pm(\Delta\theta_1 + \Delta\theta_2) = \pm(0.2 + 0.3) = \pm 0.5^\circ\text{C}$ \therefore rise in temperature = $(37.7 \pm 0.5)^\circ\text{C}$

13. Least Count

The smallest value of a physical quantity which can be measured accurately with an instrument is called the least count (L. C.) of the measuring instrument.

Least Count of Vernier Callipers

Suppose the size of one main scale division (M.S.D.) is M units and that of one vernier scale division (V. S. D.) is V units. Also let the length of 'a' main scale divisions is equal to the length of 'b' vernier scale divisions.

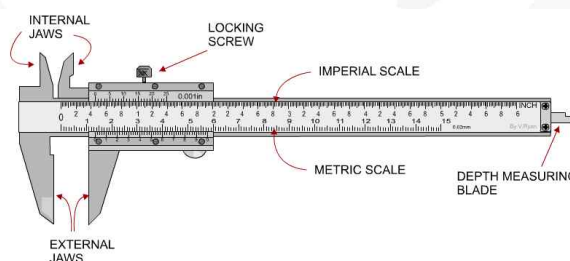

$$aM = bV \Rightarrow V = \frac{a}{b}M$$

$$\therefore M - V = M - \frac{a}{b}M \text{ or } M - V = \left(\frac{b-a}{b}\right)M$$

The quantity $(M - V)$ is called vernier constant (V. C.) or least count (L. C.) of the vernier callipers.

$$\text{L.C.} = M - V = \left(\frac{b-a}{b}\right)M$$

Least Count of screw gauge or spherometer

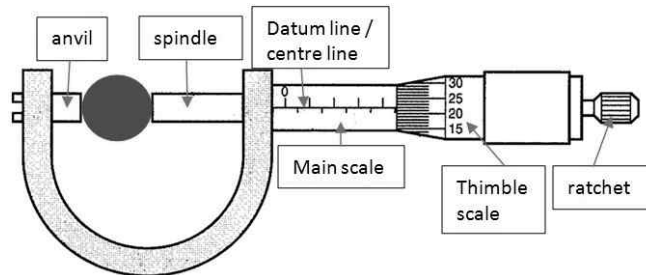

$$\text{Least Count} = \frac{\text{Pitch}}{\text{Total number of divisions on the circular scale}}$$

where pitch is defined as the distance moved by the screw head when the circular scale is given one complete rotation. i.e.

$$\text{Pitch} = \frac{\text{Distance moved by the screw on the linear scale}}{\text{No. of full rotations given}}$$

NOTE With the decrease in the least count of the measuring instrument, the accuracy of the measurement increases and the error in the measurement decreases.

Example One cm on the main scale of vernier callipers is divided into ten equal parts. If 20 divisions of vernier scale coincide with 8 small divisions of the main scale. What will be the least count of callipers ?

Solution 20 div. of vernier scale = 8 div. of main scale $\Rightarrow 1 \text{ V.S.D.} = \left(\frac{8}{20}\right) \text{ M.S.D.} = \left(\frac{2}{5}\right) \text{ M.S.D.}$

$$\begin{aligned} \text{Least count} &= 1 \text{ M.S.D.} - 1 \text{ V.S.D.} = 1 \text{ M.S.D.} - \left(\frac{2}{5}\right) \text{ M.S.D.} = \\ &= \left(1 - \frac{2}{5}\right) \text{ M.S.D.} \end{aligned}$$

$$= \frac{3}{5} \text{ M.S.D.} = \frac{3}{5} \times 0.1 \text{ cm} = 0.06 \text{ cm}$$

$$(\because 1 \text{ M.S.D.} = \frac{1}{10} \text{ cm} = 0.1 \text{ cm})$$

NOTE The final absolute error in this type of questions is taken to be equal to the least count of the measuring instrument.

JEE Main Pattern Exercise (1)

1. Match Column I with Column II and select the correct answer using the codes given below the lists.

Column I	Column II
(a) Boltzmann's constant	(p) $[ML^2T^{-1}]$
(b) Coefficient of viscosity	(q) $[ML^{-1}T^{-1}]$
(c) Planck's constant	(r) $[MLT^{-3}K^{-1}]$
(d) Thermal conductivity	(s) $[ML^2T^{-2}K^{-1}]$

2. In the equation $\int \frac{dt}{\sqrt{2at-t^2}} = a^x \sin^{-1} \left[\frac{t}{a} - 1 \right]$. The value of x is

- (a) 1 (c) 0
(b) -1 (d) 2

3. Let $[\epsilon_0]$ denote the dimensional formula of the permittivity of vacuum. If $M =$ mass, $L =$ length, $T =$ Time and $A =$ electric current, then

- (a) $[\epsilon_0] = [M^{-1} L^{-3} T^2 A]$
(b) $[\epsilon_0] = [M^{-1} L^{-3} T^4 A^2]$
(c) $[\epsilon_0] = [M^{-2} L^2 T^{-1} A^{-2}]$
(d) $[\epsilon_0] = [M^{-1} L^2 T^{-1} A^2]$

4. The equation of state of a gas is given by $\left(P + \frac{a}{V^3}\right)(V - b^2) = cT$, where P, V, T are pressure, volume and temperature respectively, and a, b, c , are constants. The dimensions of a and b are respectively.

- (a) ML^8T^{-2} and $L^{3/2}$
(b) ML^5T^{-2} and L^3
(c) ML^5T^{-2} and L^6
(d) ML^6T^{-2} and $L^{3/2}$

5. Which one of the following is NOT correct?

- (a) Dimensional formula of thermal conductivity (K) is $M^1L^1T^{-3}K^{-1}$
(b) Dimensional formula of potential (V) is $M^1L^2T^3A^{-1}$
(c) Dimensional formula of permeability of free space (μ_0) is $M^1L^1T^{-2}A^{-2}$
(d) Dimensional formula of RC is $M^0L^0T^{-1}$.

01 Units and Measurement

6. A cube has side of length 1.2×10^{-2} m. Calculate its volume.
 (a) $1.7 \times 10^{-6} \text{ m}^3$
 (b) $1.73 \times 10^{-6} \text{ m}^3$
 (c) $1.70 \times 10^{-6} \text{ m}^3$
 (d) $1.732 \times 10^{-6} \text{ m}^3$
7. The density of a solid ball is to be determined in an experiment. The diameter of the ball is measured with a screw gauge, whose pitch is 0.5 mm and there are 50 divisions on the circular scale. The reading on the main scale is 2.5 mm and that on the circular scale is 20 divisions. If the measured mass of the ball has a relative error of 2%, the relative percentage error in the density is
 (a) 0.9%
 (b) 2.4%
 (c) 3.1%
 (d) 4.2%
8. **Column I** gives three physical quantities. Select the appropriate units for the choices given in **Column II**. Some of the physical quantities may have more than one choice.

Column I	Column II
Capacitance	ohm-second
Inductance	Coulomb ² -joule ⁻¹
Magnetic induction	Coulomb (volt) ⁻¹ , Newton (ampere metre) ⁻¹ , volt-second (ampere) ⁻¹

9. In the determination of Young's modulus $\left(Y = \frac{4MLg}{\pi ld^2}\right)$ by using Searle's method, a wire of length $L = 2\text{m}$ and diameter $d = 0.5 \text{ mm}$ is used. For a load $M = 2.5 \text{ kg}$, an extension $l = 0.25 \text{ mm}$ in the length of the wire is observed. Quantities d and l are measured using a screw gauge and a micrometer, respectively. They have the same pitch of 0.5 mm. The number of divisions on their circular scale is 100. The contributions to the maximum probable error of the Y measurement is
 (a) due to the errors in the measurements of d and l are the same
 (b) due to the error in the measurement of d is twice that due the error in the measurement of l
 (c) due to the error in the measurement of l is twice that due to the error in the measurement of d
 (d) due to the error in the measurement of d is four times that due to the error in the measurement of l

10. Match the physical quantities given in **Column I** with dimensions expressed in terms of mass (M), length (L), time (T), and charge (Q) given in **Column II** and write the correct answer against the matched quantity in a tabular form in your answer book.

Column I	Column II
Angular momentum	$[ML^2T^{-2}]$
Latent heat	$[ML^2Q^{-2}]$
Torque	$[ML^2T^{-1}]$
Capacitance	$[ML^3T^{-1}Q^{-2}]$
Inductance	$[M^{-1}L^{-2}T^2Q^2]$
Resistivity	$[L^2T^{-2}]$



JEE Advanced Pattern Exercise (1)

(Only One Correct Option)

1. A person measures the depth of a well by measuring the time interval between dropping a stone and receiving the sound of impact with the bottom of the well. The error in his measurement of time is $\delta T = 0.01$ s and he measures the depth of the well to be $L = 20$ m. Take the acceleration due to gravity $g = 10 \text{ ms}^{-2}$ and the velocity of sound is 300 ms^{-1} . Then the fractional error in the measurement, $\frac{\delta L}{L}$, is closest to.

- (a) 1% (c) 3%
(b) 5% (d) 0.2%

2. If $\vec{A} \times \vec{B} = \vec{C} + \vec{D}$, then select the correct alternative.

- (a) \vec{B} is parallel to $\vec{C} + \vec{D}$
(b) \vec{A} is perpendicular to \vec{C}
(c) Component of \vec{C} along $\vec{A} =$ component of \vec{D} along \vec{A}
(d) Component of \vec{C} along $\vec{A} = -$ component of \vec{D} along \vec{A}

3. The $|\mu|, |v|$ graph for a concave mirror is as shown in figure. Here $|\mu| > |f|$. A line passing through origin of slope 1 cuts the graph at point P . Then co-ordinates of point P are

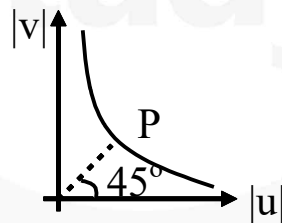

- (a) $(2f, 2f)$ (c) $(f, 2f)$
(b) $(2f, f)$ (d) (f, f)

4. The x - y plane is the boundary between two transparent media. Medium-1 with $z \geq 0$ has a refractive index $\sqrt{2}$ and medium-2 with $z \leq 0$ has a refractive index $\sqrt{3}$. A ray of light in medium-1 given by vector $\vec{A} = \sqrt{3}\hat{i} - \hat{k}$ is incident on the plane of separation. The unit vector in the direction of the refracted ray in medium-2 is

- (a) $\frac{1}{\sqrt{2}}(\hat{k} - \hat{i})$ (c) $\frac{1}{\sqrt{2}}(\hat{i} - \hat{k})$
(b) $\frac{1}{\sqrt{2}}(\hat{i} + \hat{j})$ (d) $\frac{1}{\sqrt{2}}(\hat{i} + \hat{k})$

(One or More Correct Option)

5. A length-scale (l) depends on the permittivity (ϵ) of a dielectric material, Boltzmann's constant (k_B), the absolute temperature (T) the number per unit volume (n) of certain charged particles, and the charge (q) carried by each of the particles. Which of the following expression (s) for l is (are) dimensionally correct?

(a) $l = \sqrt{\left(\frac{nq^2}{\epsilon k_B T}\right)}$

(c) $l = \sqrt{\left(\frac{q^2}{\epsilon n^{2/3} k_B T}\right)}$

(b) $l = \sqrt{\left(\frac{\epsilon k_B T}{nq^2}\right)}$

(d) $l = \sqrt{\left(\frac{q^2}{\epsilon n^{1/3} k_B T}\right)}$

6. Planck's constant h , speed of light c and gravitational constant G are used to form a unit of length L and a unit of mass M . Then, the correct options is/are

(a) $M \propto \sqrt{c}$

(c) $L \propto \sqrt{h}$

(b) $M \propto \sqrt{G}$

(d) $L \propto \sqrt{G}$

7. In terms of potential difference V , electric current I , permittivity ϵ_0 , permeability μ_0 and speed of light c , the dimensionally correct equations is/are

(a) $\mu_0 I^2 = \epsilon_0 V^2$

(c) $I = \epsilon_0 c V$

(b) $\epsilon_0 I = \mu_0 V$

(d) $\mu_0 c I = \epsilon_0 V$

(Integer Type Questions)

8. To find the distance d over which a signal can be seen clearly in foggy conditions, a railway engineer uses dimensional analysis and assumes that the distance depends on the mass density ρ of the fog, intensity (power/area) S of the light from the signal and its frequency f . The engineer finds that d is proportional to $S^{1/n}$. The value of n is
9. The energy of a system as a function of time t is given as $E(t) = A^2 \exp(-at)$, where $a = 0.2\text{s}^{-1}$. The measurement of A has an error of 1.25%. If the error in the measurement of time is 1.50%, the percentage error in the value of $E(t)$ at $t = 5$ s is

(Passage Based Questions)

10. A dense collection of equal number of electrons and positive ions is called neutral plasma. Certain solids containing fixed positive ions surrounded by free electrons can be treated as neutral plasma. Let N be the number density of free electrons, each of mass m . When the electron are subjected to an electric field, they are displaced relatively away from the heavy positive ions. If the electric field becomes zero, the electrons begin to oscillate about the positive ions with a natural angular frequency ω_p , which is called the plasma frequency. To sustain the oscillations, a time varying electric field needs to be applied that has an angular frequency ω , where a part of the energy is absorbed and a part of it is reflected. As ω approaches ω_p , all the free electrons are set to resonance together and all the energy is reflected. This is the explanation of high reflectivity of metals.

- (i) Taking the electronic charge as e and the permittivity as ϵ_0 , use dimensional analysis to determine the correct expression for ω_p .

(a) $\sqrt{\frac{Ne}{m\epsilon_0}}$

(b) $\sqrt{\frac{m\epsilon_0}{Ne}}$

(c) $\sqrt{\frac{Ne^2}{m\epsilon_0}}$

(d) $\sqrt{\frac{m\epsilon_0}{Ne^2}}$

- (ii) Estimate the wavelength at which plasma reflection will occur for a metal having the density of electrons $N = 4 \times 10^{27} \text{ m}^{-3}$. Take $\epsilon_0 \approx 10^{-30}$, and $m \approx 10^{-30}$, where these quantities are in proper SI units.

(a) 800 nm

(b) 600 nm

(c) 300 nm

(d) 200 nm

JEE

CHEMISTRY

- ▶ Specially designed eBook for complete JEE syllabus
- ▶ JEE preparation strategy & direction, speedy revision
- ▶ Chapter-wise important Problem-Solving
- ▶ Theory, Formulas & Diagrams to crack JEE
- ▶ Detailed high quality video lectures by experienced faculties
- ▶ JEE full preparation for Class XI & XII



misostudy
connect smart learning

JEE·NEET·AIIMS·CBSE·FOUNDATION
www.misostudy.com

☎ 8929803804 (MON-FRI: 9am-6pm) support@misostudy.com

MISO STUDY INDIA PVT. LTD.
2ND FLOOR 65-A, OMPRO TOWER, KALU SARAI, NEW DELHI, DELHI 110016

Class 11 | Chemistry

02 Mole Concept

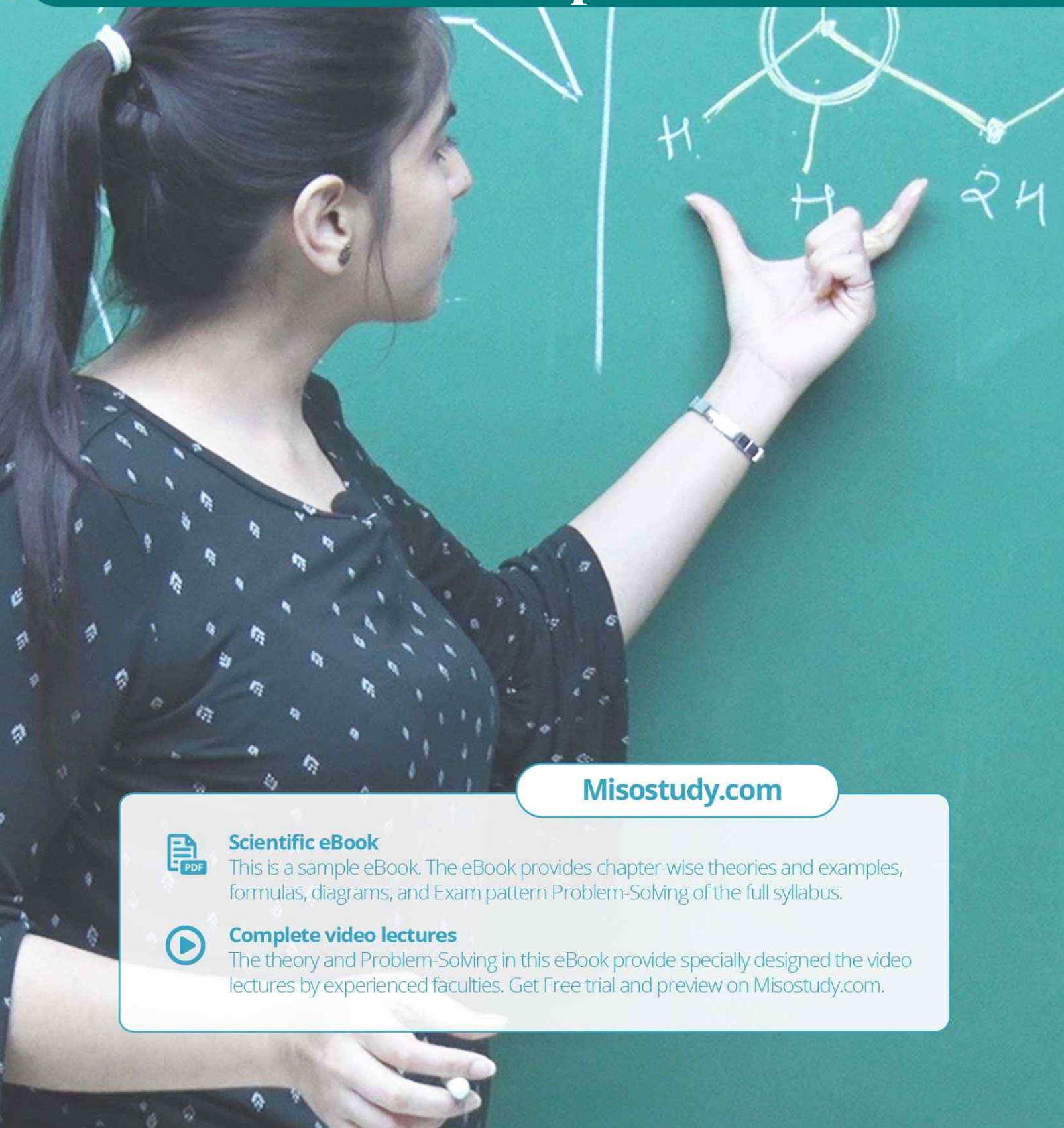

Misostudy.com



Scientific eBook

This is a sample eBook. The eBook provides chapter-wise theories and examples, formulas, diagrams, and Exam pattern Problem-Solving of the full syllabus.



Complete video lectures

The theory and Problem-Solving in this eBook provide specially designed the video lectures by experienced faculties. Get Free trial and preview on Misostudy.com.

01. Classification of matter

Chemistry deals with the composition, structure and properties of matter. These aspects can be best described and understood in terms of basic constituents of matter: **atoms** and **molecules**. That is why chemistry is called the science of atoms and molecules.

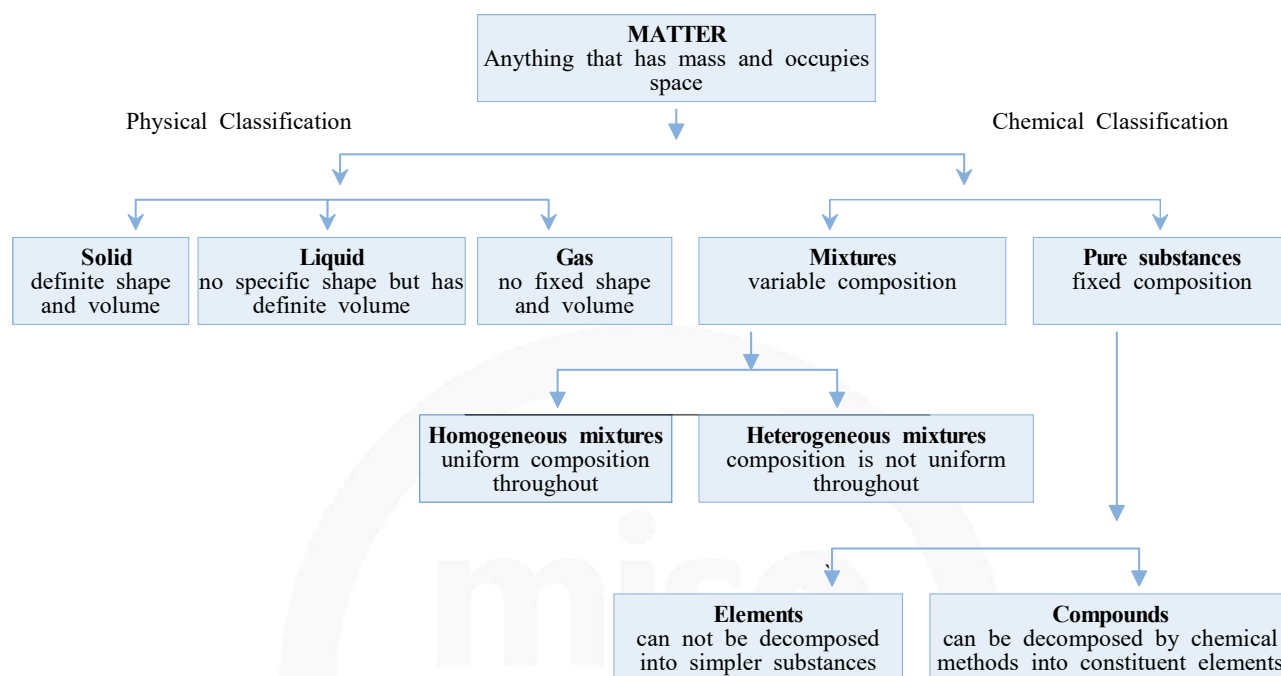

Matter

The thing which occupy space and have mass, which can be felt by our five sense is called as matter. Matter is further classified into two categories :

- a. Physical classification
- b. Chemical classification

02. Prefixed Used With Units

The S.I. system recommends the multiples such as 10^3 , 10^6 , 10^9 etc. and fraction such as 10^{-3} , 10^{-6} , 10^{-9} etc. i.e. the powers are the multiples of 3. These are indicated by special prefixes. These along with some other fractions or multiples in common use, along with their prefixes are given below in Table and illustrated for length (m).

※TABLE : SOME COMMONLY USED PREFIXES WITH THE BASE UNIT

Prefix	Symbol	Multiplication Factor	Example
deci	d	10^{-1}	1 decimetre (dm) = 10^{-1} m
centi	c	10^{-2}	1 centimetre (cm) = 10^{-2} m
milli	m	10^{-3}	1 millimetre (mm) = 10^{-3} m
micro	μ	10^{-6}	1 micrometre (μm) = 10^{-6} m
nano	n	10^{-9}	1 nanometre (nm) = 10^{-9} m
pico	p	10^{-12}	1 picometre (pm) = 10^{-12} m
femto	f	10^{-15}	1 femtometre (fm) = 10^{-15} m
atto	a	10^{-18}	1 attometre (am) = 10^{-18} m
deka	da	10^1	1 dekametre (dam) = 10^1 m
hecto	h	10^2	1 hectometre (hm) = 10^2 m
kilo	k	10^3	1 kilometre (km) = 10^3 m
mega	M	10^6	1 megametre (Mm) = 10^6 m
giga	G	10^9	1 gigametre (Gm) = 10^9 m
tera	T	10^{12}	1 terametre (Tm) = 10^{12} m
peta	P	10^{15}	1 petametre (Pm) = 10^{15} m
exa	E	10^{18}	1 exametre (Em) = 10^{18} m

As volume is very often expressed in litres, it is important to note that the equivalence in S.I. units for volume is as under: 1 litre (1 L) = $1 \text{ dm}^3 = 1000 \text{ cm}^3$ and 1 millilitre (1 ml) = $1 \text{ cm}^3 = 1 \text{ cc}$

Example Convert 2 atm into cm of Hg.

Solution $2 \text{ atm} = 2 \times 76 \text{ cm of Hg} = 152 \text{ cm of Hg}$ {1 atmosphere = 76 cm of Hg}

03. Different types of masses

One mole

Avogadro's Number (N_A) = 6.023×10^{23} . It is the number of atoms present in exactly 12 g of (C^{12}) isotope.

Atomic Weight (A)

Atomic weight is the relative weight of one atom of an element with respect to a standard weight.

$$A = \frac{\text{Weight of one atom of an element}}{\frac{1}{12} \text{th part by weight of an atom of } (\text{C}^{12}) \text{ isotope}}$$

amu (atomic mass unit)

$$1 \text{ amu} = \frac{1}{12} \text{th part by weight of an atom of } (\text{C}^{12}) \text{ isotope}$$

$$= \frac{1}{N_A} g = 1.66 \times 10^{-24} g$$

Atomic weight (A) × amu = Absolute atomic weight.

NOTE  Atomic weight is a relative weight that indicates the relative heaviness of one atom of an element with respect to amu weight. Atomic weight has no unit because it is the ratio of weights. One mole of an amu = 1.00 g.

Change of Scale for Atomic Weight

If an amu is defined differently as $(1/x)$ th part by weight of an atom of (C^{12}) isotope rather $(1/12)$ th part then the atomic weight (A') can be derived as:

$$A' = A \left(\frac{x}{12} \right)$$

Where, A = conventional atomic weight

Molecular Weight (MW)

Like atomic weight, it is the relative weight of a molecule or a compound with respect to amu weight.

$$\text{Molecular Weight} = \frac{\text{Weight of one molecule of a compound}}{\frac{1}{12} \text{th part by weight of an atom of } C^{12} \text{ isotope}}$$

Gram Atomic, Gram Molecular Weight (M)

It is the weight of 1.0 mole (Avogadro's numbers) of atoms, molecules or ions in gram unit.

$M = A \text{ amu} \times \text{Avogadro number} = A \text{ gram}$ Hence, gram molecular weight (M) is numerically equal to the atomic weight or (molecular weight) in gram unit because 1.0 mole of amu is 1.0 g.

Example A piece of Cu contain 6.022×10^{24} atoms. How many mole of Cu atoms does it contain?

Solution No. of mole = $\frac{6.022 \times 10^{24}}{N_A} = \frac{6.022 \times 10^{24}}{6.022 \times 10^{23}} = 10 \text{ mole}$

04. Law of conservation of mass (Lavoisier-1774):

In any physical or chemical change, mass can neither be created nor be destroyed.

It means:

Total mass of the reactants = total mass of the products.

This relationship holds good when reactants are completely converted into products.

In case the reacting material are not completely consumed the relationship will be-

Total mass of the reactants = Total mass of the products + mass of unreacted reactants.

Example 1.7 gram of silver nitrate dissolved in 100 gram of water is taken. 0.585 gram of sodium chloride dissolved in 100 gram of water is added it and chemical reaction occurs. 1.435 gm of AgCl and 0.85 gm $NaNO_3$ are formed. Show that these results illustrate the law of conservation of mass.

02 Mole Concept

Solution

Total masses before chemical change
 = mass of AgNO_3 + mass of NaCl + mass of water
 = $1.70 + 0.585 + 200\text{g}$
 = 202.285 g

Total masses after the chemical reaction
 = mass of AgCl + mass of AgNO_3 + mass of water
 = $1.435 + 0.85 + 200$
 = 202.258 g

Then, in this chemical change
 Total masses of reactants = Total masses of product

05. Law of constant composition : [proust 1799]

A chemical compound always contains the same element combined together in fixed proportion by mass.

Example

1.08 gram of Cu wire was allowed to react with nitric acid. The resulting solution was dried and ignited when 1.35 gram of copper oxide was obtained. In another experiment 1.15 gram of copper oxide was heated in presence of Hydrogen yielding 0.92 gram of copper. Show that the above data are in accordance with law of constant composition?

Solution

% of "Cu" in copper oxide in 1st case = $\frac{1.08}{1.35} \times 100$
 = 80%

% of oxygen = 20%

% of "Cu" in copper oxide in 2nd case = $\frac{0.92}{1.15} \times 100$
 = 80%

% of oxygen = 20%

06. Law of multiple proportion : [Dalton 1806]

When two elements combine to form two or more compounds, the different masses of one element which combine with a fixed mass of the other element, bear a simple ratio to one another.

Example

Two compounds each containing only tin and oxygen had the following composition.

	Mass % of Tin	Mass % of oxygen
Compound A	78.77	21.23
Compound B	88.12	11.88

Show that these data illustrate the law of multiple proportion?

Solution

In compound A
 21.23 parts of oxygen combine with 78.77 parts of tin.
 1 part of oxygen combine with $\frac{78.77}{21.23} = 3.7$ parts of Sn.

In compound B

11.88 parts of oxygen combine with 88.12 parts of tin.

1 part of oxygen combine with $\frac{88.12}{11.88} = 7.4$ parts of tin.

Thus the mass of Tin in compound A and B which combine with a fixed mass of oxygen are in the ratio 3.7:7.4 or 1:2. This is a simple ratio. Hence the data illustrate the law of multiple proportion.

07. Law of reciprocal proportion : [Richter 1794]

When two different elements combine with the same mass of a third element, the ratio on which the do so will be same or simple multiple if both directly combined with each other.

Example

The % composition of NH_3 , H_2O and N_2O_3 is as given below:

$\text{NH}_3 \rightarrow 82.35\% \text{ N and } 17.65 \text{ H.}$

$\text{H}_2\text{O} \rightarrow 88.9\% \text{ O and } 11.1 \text{ H}$

$\text{N}_2\text{O}_3 \rightarrow 63.15\% \text{ O and } 36.85\% \text{ N}$

On the basis of above data prove the law of reciprocal proportion?

Solution

63.15 parts of oxygen combine with 36.85 parts of "N"

Therefore, 88.9 part of oxygen combine with $\left(\frac{36.85}{63.15} \times 88.9\right) = 51.87$ part of "Nitrogen"

Therefore ratio is $\frac{11.1}{11.1} : \frac{51.87}{11.1} = 1 : 4.67$

Now compare with the ratio of Nitrogen and Hydrogen in NH_3

$$\frac{17.65}{17.65} : \frac{82.35}{17.65} = 1 : 4.67$$

Hence the Law of reciprocal proportion is verified

08. Gay- Lussac's law of gaseous volumes [Gay-Lussac-1808]

When gases combined or produced in a chemical reaction, they do so in a simple ratio by volume provided all the gases are at same temperature and pressure.

09. Limiting Reagent

It is the reagent that is consumed completely during a chemical reaction. If the supplied mass ratio of reactants are not stoichiometric ratio, one of the reagent is consumed completely leaving parts of others unreacted. One that is consumed completely is known as limiting reagent.

'Limiting reagent determine the amount of product in a given chemical reaction'

Example

If 20 gm of CaCO_3 is treated with 20 gm of HCl, how many grams of CO_2 can be generated according to following reaction?

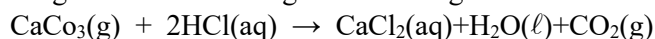
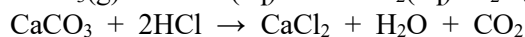
**Solution**

1 mole $\text{CaCO}_3 \rightarrow 2$ mole HCl

$\therefore 100 \text{ g CaCO}_3 \text{ combine} \rightarrow 2 \times 36.5 \text{ g HCl}$

$$\therefore 20 \text{ g} \rightarrow \frac{2 \times 36.5 \times 20}{100} = 14.6 \text{ HCl}$$

CaCO₃ completely consumes in the reaction and HCl is in excess.

Therefore,

CaCO₃ → Limiting reagent

HCl → Excess reagent

Now

100 g CaCO₃ given 1 mole CO₂ (44g CO₂)

20 g CaCO₃ will give $\frac{20 \times 40}{100} = 8 \text{ g CO}_2$

10. Percentage yield

In general, when a reaction is carried out on the laboratory we do not obtain the theoretical amount of product. The amount of product that is actually obtained is called the actual yield. Knowing the actual yield and theoretical yield, the % yield can be calculated by the following formula-

$$\text{Percentage yield} = \frac{\text{Actual yield}}{\text{Theoretical yield}} \times 100\%$$

Example

For the reaction

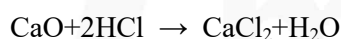

1.12 gram of CaO is reacted with excess of hydrochloric acid and 1.85 gm CaCl₂ is formed. What is the % yield of the reaction?

Solution

1 mole CaO gives 1 mole CaCl₂

56 g CaO gives 111 g CaCl₂

1.12 g CaO will give $\frac{111 \times 1.12}{56} \text{ g CaCl}_2 = 2.22 \text{ g CaCl}_2$

Now

$$\% \text{ yield} = \frac{\text{Actual yield}}{\text{Theoretical yield}} \times 100$$

Actual yield = 1.85 gm

Theoretical yield = 2.22 gm

$$\% \text{ yield} = \frac{1.85}{2.22} \times 100 = 83.33\%$$

11. Percentage Purity

Depending upon the mass of the product, the equivalent amount of reactant present can be determined with the help of given chemical equation. Knowing the actual amount of the reactant taken and the amount calculated with the help of a chemical equation, the purity can be determined, as

$$\text{Percentage purity} = \left[\frac{\text{Amount of reactant calculated from the chemical equation}}{\text{Actual amount of reactant taken}} \right] \times 100\%$$

02 Mole Concept

Example Calculate the amount of (CaO) in kg that can be produced by heating 200 kg lime stone that is 90% pure CaCO₃.

Solution CaCO₃ → CaO + CO₂
 1 mole CaCO₃ gives 1 mole CaO
 100 g CaCO₃ gives 56 g CaO
 $\left(\frac{200 \times 90 \times 1000}{100}\right)$ g CaCO₃ gives = $\frac{180000 \times 56}{100}$ g CaO
 = $\frac{1800 \times 56}{100}$ g CaO
 = $\frac{1008}{10}$ g CaO
 = 100.8 g CaO

12. Types of Average masses

Average Atomic Mass

Average atomic mass =

Let a sample contains n₁ mole of atomic mass M₁ and n₂ mole of atoms with atomic mass M₂ then

$$M_{av} = \frac{n_1 M_1 + n_2 M_2}{n_1 + n_2}$$

Average Molecular Mass

Average molecular mass =

Let a sample contains n₁ mole of molecules with molecular mass M₁ and n₂ mole of molecules with molecular mass M₂, then

$$M = \frac{n_1 M_1 + n_2 M_2}{n_1 + n_2}$$

Example Find the average atomic mass of a mixture containing 25% by mole Cl³⁷ and 75% by mole Cl³⁵?

Solution n₁ = 25 n₂ = 75 M₁ = 37 M₂ = 35

$$M_{av} = \frac{25 \times 37 + 75 \times 35}{25 + 75} = 35.5$$

13. Empirical & molecular formula

The empirical formula of a compound is a chemical formula showing the relative number of atoms in the simplest ratio. An empirical formula represents the simplest, whole number ratio of various atoms present in a compound.

The molecular formula gives the actual number of atoms of each element in a molecule. The molecular formula shows the exact number of different types of atoms present in a molecule of a compound. The molecular formula is an integral multiple of the empirical formula.

$$\text{i.e. molecular formula} = \text{empirical formula} \times n \quad \text{where } n = \frac{\text{molecular formula mass}}{\text{empirical formula mass}}$$

Example

An organic substance containing carbon, hydrogen and oxygen gave the following percentage composition.

C=40,684% ; H=5,085% ; and O=54,228%

The molecular weight of the compound is 118 g. Calculate the molecular formula of the compound.

Solution

Step-1 : To calculate the empirical formula of the compound.

Element	Sym bol	percent age of element	At. mass of element	Relative no. of atoms= $\frac{\text{Percentage}}{\text{At. mass}}$	Simplest atomic ratio	Simplest whole no. atomic ratio
Carbon	C	40.678	12	$\frac{40.678}{12} = 3.390$	$\frac{3.390}{3.389} = 1$	2
Hydrogen	H	5.085	1	$\frac{5.085}{1} = 5.085$	$\frac{5.085}{3.389} = 1.5$	3
Oxygen	O	54.228	16	$\frac{54.228}{16} = 3.389$	$\frac{3.389}{3.389} = 1$	2

\therefore Empirical Formula is $C_2 H_3 O_2$

Step-2 : To calculate the empirical formula mass. The empirical formula of the compound is $C_2 H_3 O_2$.

$$\text{Empirical formula mass} = (2 \times 12) + (3 \times 1) + (2 \times 16) = 59.$$

Step-3 : To calculate the value of 'n' $n = \frac{\text{Molecular mass}}{\text{Empirical formula mass}} = \frac{118}{59} = 2$

Step-4 : To calculate the molecular formula of the salt.

$$\text{Molecular formula} = n \times (\text{Empirical formula}) = 2 \times C_2H_3O_2 = C_4H_6O_4$$

Thus the molecular formula is $C_4H_6O_4$

14. Vapour Density

Some times in numericals molecular mass of volatile substance is not given, instead vapour density is given. Vapour density can be defined as

$$\text{V.D.} = \frac{\text{Density of gas at a given T and P}}{\text{Density of H}_2 \text{ at same T and P}}$$

$$\text{or, V.D.} = \frac{M_{\text{gas}}}{2}$$

$$M_{\text{gas}} = 2 \times \text{V.D.}$$

15. Eudiometry – Gas Analysis

The study of gaseous reactions is done in a eudiometer tube with the help of Gay-Lussac's law and Avogadro's law. Eudiometer tube is a closed graduated tube open at one end. The other end is a closed one which is provided with platinum terminals for passing electricity for electric spark, through the known volume of mixture of gases and known volume of oxygen gas. Volume of CO₂ formed is determined by absorbing in KOH solution, O₂ is determined by dissolving unreacted O₂ in alkaline pyrogallol and water vapours formed are determined by nothing contraction in volume caused due to cooling.

16. Avogadro's Law

In 1812, Amadeo Avogadro stated that samples of different gases which contain the same number of molecules (any complexity, size, shape) occupy the same volume at the same temperature and pressure.

For ideal gas at constant Temperature & Pressure, pressure is directly proportional to no. of moles

17. Some Absorbents of Gases

The absorbent which is used for specific gas is listed below

Absorbent	Gas or gases absorbed
Turpentine oil	O ₃
Alkaline pyrogallol	O ₂
Ferrous sulphate solution	NO
Heated magnesium	N ₂
Heated palladium	H ₂
Ammonical cuprous chloride	O ₂ , CO, C ₂ H ₂ or CH ≡ CH
Copper sulphate solution	H ₂ S, PH ₃ , AsH ₃
Conc. H ₂ SO ₄	H ₂ O I.e., moisture, NH ₃ .
NaOH or KOH solution	CO ₂ , NO ₂ , SO ₂ , X ₂ , all acidic oxides

02 Mole Concept

18. Volume Expansion and Contraction In The Eudiometer Tube

$$aA(g) + bB(g) \quad cC(g) + dD(g)$$

$$\Delta n_g = \text{No. of gaseous products} - \text{No. of gaseous reactants} = (c+d) - (a+b)$$

- (a) If $\Delta n_g > 0$, then expansion will occur
 (b) If $\Delta n_g = 0$, No contraction/expansion (volume remains constant)
 (c) If $\Delta n_g < 0$, then contraction will occur

19. Assumptions

- (i) All gases are assumed to be ideal.
 (ii) Nitrogen gas formed during reaction will not react with any other gas.
 (iii) The volume of solids and liquids are negligible in comparison to the volume of gas.

20. General Reactions for Combustion of Organic Compounds

- (i) When an organic compound is hydrocarbon :

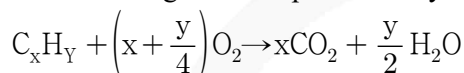

- (ii) When an organic compound contain carbon, hydrogen and oxygen :

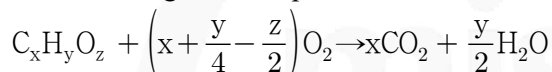

- (iii) When an organic compound contain carbon, hydrogen and nitrogen :

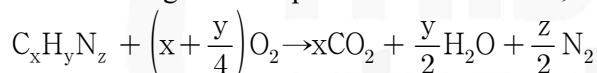

Example

10 ml of a mixture of CO, CH₄ and N₂, exploded with excess of oxygen, gave a contraction of 6.5 ml. There was a further contraction of 7 ml. when the residual gas was treated with KOH. What is the composition of the original mixture?

Solution

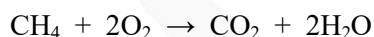

$$x \text{ ml} \quad \frac{x}{2} \text{ ml} \quad x \text{ ml}$$

$$y \text{ ml} \quad 2y \text{ ml} \quad y \text{ ml}$$

$$\text{volume of oxygen used} = 2y + \frac{x}{2} \text{ ml}$$

$$\text{Total volume of all gases before combustion} = 10 + 2y + x/2$$

21. Percentage

Concentration of solution is the amount of solute dissolved in a known amount of the solvent or solution. The concentration of solution can be expressed in various ways as discussed below.

It refers to the amount of the solute per 100 parts if the solution. It can also be called as parts per hundred (pph). It can be expressed by any of following four methods:

- (i) **Weight by weight percentage (%w/w)** = $\frac{\text{Wt. of solute (g)}}{\text{Wt. of solution (g)}} \times 100$
e.g., 10%Na₂CO₃ solution w/w means 10 g of Na₂CO₃ is dissolved in 100 g of the solution. (It means 10 g Na₂CO₃ is dissolved in 90 of solvent)
- (ii) **Weight by volume percent (%w/v)** = $\frac{\text{Wt. of solute (g)}}{\text{Wt. of solution (cm}^3\text{)}} \times 100$
e.g., 10%Na₂CO₃ (w/v) means 10 g Na₂CO₃ is dissolved in 100 cm³ of solution
- (iii) **Volume by volume percent (%v/v)** = $\frac{\text{Volume of solute (cm}^3\text{)}}{\text{Volume of solution (cm}^3\text{)}} \times 100$
e.g., 10% ethanol (v/v) means 10 cm³ of ethanol dissolved in 100 cm³ of solution.
- (iv) **Volume by volume percent (%v/v)** = $\frac{\text{Vol. of solute}}{\text{Wt. of solution}} \times 100$
e.g., 10% ethanol (v/w) means 10 cm³ of ethanol dissolved in 100 g of solution.

Example Concentrated nitric acid used as laboratory reagent is usually 69% by mass of nitric acid. Calculate the volume of the solution which contains 23 g nitric acid. The density of concentrated acid is 1.41 g cm⁻³.

Solution 69 g of HNO₃ in 100 g solution
given density = 1.41 g/cc

$$\text{density} = \frac{\text{mass}}{\text{volume}}$$

$$\text{volume} = \frac{\text{mass}}{\text{density}} = \frac{10000}{1.41} \text{ cc}$$

Now,

69 g HNO₃ is in $\frac{10000}{141}$ volume solution

23 g HNO₃ → $\frac{23}{69} \times \frac{10000}{141}$ volume solution = **23.64 cm³**

22. Molarity (M)

The number of moles of solute dissolved in one litre solution is called its molarity.

$$\text{Molarity} = \frac{\text{Number of moles of solute}}{\text{volume of solution in litres}} = \frac{n}{V}$$

$$\text{weight of solute in gram} = \frac{\text{Molarity} \times \text{Volume of solution in mL} \times \text{molecular weight}}{1000}$$

$$\text{Molarity} = \frac{\text{Numbers of moles of solute} \times 1000}{\text{Volume of solution in mL}}$$

$$= \frac{\text{weight of solute in grams} \times 1000}{\text{Molecular weight} \times \text{Volume of solution in mL}}$$

$$= \frac{\text{strength of solution in gram/litre}}{\text{Molecular weight of solute}} = \text{Normality} \times \frac{\text{Equivalent weight of solute}}{\text{Molecular weight of solute}}$$

02 Mole Concept

Example A bottle of commercial sulphuric acid (density 1.787 g ml^{-1}) is labelled as 86% by weight. What is the molarity of acid?

Solution 86 g H_2SO_4 is in 100 g solution

Now

$$\begin{aligned} \text{density} &= \frac{\text{mass}}{\text{volume}} \\ 1.78 &= \frac{100}{V} \\ V &= \frac{10000}{1.78} = 56.18 \text{ ml.} \end{aligned}$$

Again

$$\begin{aligned} \text{molarity(M)} &= \frac{\text{no. of moles of } \text{H}_2\text{SO}_4 \times 1000}{\text{Volume of sol. in ml.}} \\ &= \frac{\left(\frac{86}{98}\right) \times 1000}{56.18} = \mathbf{15.62 \text{ M}} \end{aligned}$$

23. Molarity (m)

The number of moles or gram molecules of solute dissolved in 1000 gram of the solvent is called molality of the solution.

$$\text{Molality of a solution} = \frac{\text{Number of moles of solute}}{\text{Amount of solvent in kg}} = \frac{\text{Number of moles of solute} \times 1000}{\text{Amount of solvent in gram}}$$

It is independent of temperature.

24. Parts per million (ppm) and parts per billion (ppb)

When a solute is present in very small quantity, it is convenient to express the concentration in parts per million and parts per billion. It is the number of parts of solute per million (10^6) or per billion (10^9) parts of solution. It is independent of the temperature.

$$\text{ppm} = \frac{\text{Mass of solute component}}{\text{Mass of solution}} \times 10^6$$

$$\text{ppb} = \frac{\text{Mass of solute component}}{\text{Mass of solution}} \times 10^9$$

Example Calculate the parts per million of SO_2 gas in 250 ml water (density 1 g cm^{-3}) containing 5×10^{-4} g of SO_2 gas.

Solution Mass of SO_2 gas = 5×10^{-4} g; Mass of H_2O = Volume \times Density
= $250 \text{ cm}^3 \times 1 \text{ g cm}^{-3} = 250 \text{ g}$

$$\therefore \text{Parts per million of } \text{SO}_2 \text{ gas} = \frac{5 \times 10^{-4}}{250 \text{ g}} \times 10^6 = 2$$

25. Formality (F)

Formality of solution may be defined as the number of gram formula units of the ionic solute dissolved per litre of the solution. It is represented by **F**. Commonly, the term formality is used to express the concentration of the ionic solids which do not exist as molecules but exist as network of ions. A solution containing one gram formula mass of solute per liter of the solution has formality equal to one and is called **Formal solution**. It may be mentioned here that the formality of a solution changes with change in temperature.

$$\text{Formality(F)} = \frac{\text{Number of gram formula units of solute}}{\text{Volume of solution in litres}}$$

$$= \frac{\text{Mass of ionic solute (g)}}{\text{gram formula unit mass of solute} \times \text{Volume of solution (l)}}$$

Example What will be the formality of KNO_3 solution having strength equal to 2.02 g per litre?

Solution Strength of $\text{KNO}_3 = 2.02 \text{ gL}^{-1}$ and g formula weight of $\text{KNO}_3 = 101 \text{ g}$

$$\therefore \text{Formality of } \text{KNO}_3 = \frac{\text{strength in } \text{g}^{\text{L}^{-1}}}{\text{g. formula wt. of } \text{KNO}_3} = \frac{2.02}{101} = \mathbf{0.02F}$$

26. Mole fraction (x)

The ratio of moles of one component to the total number of moles of all the components present in the solution, is called the mole fraction of that component.

Mole fraction of solute X_A is given by $X_A = \frac{n_A}{n_A + n_B}$

Mole fraction of solute X_B is given by $X_B = \frac{n_B}{n_A + n_B}$

where n_A is moles of solute A and n_B is moles of solvent B.

27. Mass Fraction

Mass fraction of a component in a solution is the mass of the component divided by the total mass of the solution. For a solution containing w_A gm of A and w_B gm of B.

$$\text{Mass fraction of A} = \frac{W_A}{W_A + W_B} \qquad \text{Mass fraction of B} = \frac{W_B}{W_A + W_B}$$

NOTE It may be noted that molarity, mole fraction, mass fraction etc. are preferred to molarity, normality, formality etc. Because the former involve the weights of the solute and solvent whereas the latter involve volumes of solutions. Temperature has no effect on weights but it has significant effect on volumes.

28. Equivalent Weight

Equivalent weight of an element is that part by weight which combines with 1.0 g of hydrogen or 8.0 g of oxygen or 35.5 g of chlorine.

$$(i) \text{ Equivalent weight of a salt (EW)} = \frac{\text{Molar mass}}{\text{Net positive (or negative) valency}}$$

e.g. Equivalent weight $\text{CaCl}_2 = \frac{M}{2}$, $\text{AlCl}_3 = \frac{M}{3}$, $\text{Al}_2(\text{SO}_4)_3 = \frac{M}{6}$

$$(ii) \text{ Equivalent weight of acids} = \frac{\text{Molar mass}}{\text{Basicity}}$$

e.g. Equivalent weight $\text{HCl} = M$ (basicity = 1); $\text{H}_2\text{SO}_4 = \frac{M}{2}$ (basicity = 2)

$$\text{H}_3\text{PO}_4 = \frac{M}{3} \text{ (basicity = 3)}$$

$$(iii) \text{ Equivalent weight of bases} = \frac{\text{Molar mass}}{\text{Acidity}}$$

e.g. Equivalent weight $\text{NaOH} = M$, $\text{Ca}(\text{OH})_2 = \frac{M}{2}$, $\text{Al}(\text{OH})_3 = \frac{M}{3}$

The number of gram-equivalents (Eq)

$$\text{Equivalent} = \frac{\text{Weight of compound}}{\text{Equivalent weight}} = \frac{w}{\text{Equivalent weight}}$$

Mole Equivalent Relationship In a given weight (w) of sample, number of moles (n) and number of equivalents (eq) are related as

$$n = \frac{w}{m} \text{ and } \text{Eq} = \frac{w}{\text{Equivalent weight}}$$

$$\frac{\text{Eq}}{n} = \frac{M}{\text{Equivalent weight}} = n - \text{factor}$$

n-factor For salt, it is valency, for acid it is basicity, for base it is acidity.

Normally/Molarity Relationship

$$N = \frac{\text{Eq}}{V} \text{ and } M = \frac{n}{V} \Rightarrow \frac{N}{M} = \frac{\text{Eq}}{n} = \frac{MW}{EW} = n - \text{factor}$$

29. Relation Between Molarity And Normality

$S = \text{Molarity} \times \text{molecular weight of solute}$ and $S = \text{Normality} \times \text{equivalent weight of solute}$.

So we can write

$\text{Molarity} \times \text{molecular weight of solute} = \text{Normality} \times \text{equivalent weight of solute}$.

$$\text{Normality} = \frac{\text{molarity} \times \text{molecular weight of solute}}{\text{equivalent weight of solute}} = \frac{\text{molarity} \times \text{molecular weight of solute}}{(\text{molecular weight of solute} / \text{valency factor})}$$

$\text{Normality} = \text{molarity} \times \text{valency factor}$

$$N = M \times n \quad ; \quad N > M$$

Example Calculate the molarity and molality of a solution of H_2SO_4 (sp. gr.=1.98) containing 27% H_2SO_4 by mass.
3.3 M, 3.77 M

Solution

$$\text{Vol of 100 g of 27\% H}_2\text{SO}_4 = \frac{\text{wt.}}{d} = \frac{100}{1.098} \text{ ml}$$

$$M_{\text{H}_2\text{SO}_4} = \frac{\text{wt./mol.wt.}}{\text{vol, of solution (litre)}} = \frac{27 \times 1.198 \times 1000}{98 \times 100} = 3.3 \text{ mol L}^{-1}$$

$$M_{\text{H}_2\text{SO}_4} = \frac{\text{wt./mol.wt.}}{\text{vol, of solvent (kg)}} = \frac{27 \times 1000}{(100-27) \times 98} = 3.77 \text{ mol Kg}^{-1}$$

30. Dilution Formula

If a concentrated solution is diluted, following formula work

$$M_1 V_1 = M_2 V_2$$

(M_1 and V_1 are the molarity and volumes before dilution and M_2 and V_2 are molarity and volumes after dilution)

31. Mixing of two or more solutions of different molarities

If two or more solutions of molarities (M_1, M_2, M_3, \dots) are mixed together, molarity of the

resulting

$$M = \frac{M_1 V_1 + M_2 V_2 + M_3 V_3 \dots}{V_1 + V_2 + V_3 \dots}$$

solution can be worked out as :

32. Strength of H₂O₂ solution

The strength of H₂O₂ aqueous solution is expressed in the following two ways:

(i) Percentage strength

The mass of H₂O₂ present in 100 ml of the aqueous solution is termed as percentage strength. For example, a 25% solution (w/v) of H₂O₂ means that 25 grams of H₂O₂ are present in 100 ml of the solution.

(ii) Volume strength

Strength of the sample of H₂O₂ is generally expressed in terms of the volume of oxygen at 0°C and 1 atm that one volume of the sample of hydrogen peroxide gives on heating. The commercial samples are marked as '10 volume', '15 volume' or '20 volume'. 10 volume means that one volume of the sample of hydrogen peroxide gives 10 volumes of oxygen at 0°C and 1 atm. 1 ml of a 10 volume solution of H₂O₂ will liberate 10 ml of oxygen at 0°C and 1 atm.

33. Percentage labelling of oleum

Oleum is fuming sulphuric acid which contains extra SO₃ dissolved in H₂SO₄. To convert this extra SO₃ into H₂SO₄, water has to be added (SO₃+H₂O → H₂SO₄). The amount of sulphuric acid obtained when just sufficient water is added into 100 g of oleum so that all SO₃ present in it is converted into H₂SO₄ is called percentage labelling of oleum.

34. Relationship Between Different Concentration Terms

(i) $N = M \times n \text{ factor}$

(ii) $M = \frac{md}{1 + mM_2/1000}$

(iii) $m = \frac{1000 \times x_2}{x_1 M_1}$

(iv) $M = \frac{1000 \times dx_2}{x_1 M_1 + x_2 M_2}$

(v) $d = M \left(\frac{1}{m} + \frac{M_2}{1000} \right)$

(vi) Volume strength of H₂O₂ = $5.6 \times N = \frac{5.6 \times \text{Percentage strength}}{\text{Eq. wt. of H}_2\text{O}_2 (17)} \times 10$

(vii) Volume strength of H₂O₂ = $11.2 \times M = \frac{11.2 \times \text{Percentage strength} \times 10}{\text{Mol. wt. of H}_2\text{O}_2 (34)}$

(viii) In oleum labelled as (100 + x)%
% of free SO₃ = $\left(\frac{80 \times x}{18} \right)$ (w/w)

where N =Normality

M = Molarity

m = molarity

d = density of solution

M_2 = Molecular mass of solute

x_2 = Mole fraction of solute

x_1 = Mole fraction of solvent

M_1 = Molecular mass of solvent

d = Density of solution

misostudy

JEE Main Pattern Exercise (1)

- Q1. The ratio mass of oxygen and nitrogen of a particular gaseous mixture is 1:4. The ratio of number of their molecule is
- (a) 1:4
(b) 7:32
(c) 1:8
(d) 3:16
- Q2. The molarity of a solution obtained by mixing 750 mL of 0.5 M HCl with 250 mL of 2 M HCl will be
- (a) 0.875
(b) 1.00M
(c) 1.75M
(d) 0.0975M
- Q3. The normality of 0.3 M phosphorus acid (H_3PO_3) is
- (a) 0.1
(b) 0.9
(c) 0.3
(d) 0.6
- Q4. Dissolving 120 g of urea (mol. wt. 60) in 1000g of water gave a solution of density 1.15 g/mL. The molarity of the solution is
- (a) 1.78M
(b) 2.00M
(c) 2.05M
(d) 2.22M
- Q5. The mass of Mg_3N_2 produced if 48 gm of Mg metal is reacted with 34 gm NH_3 gas is
- $$\text{Mg} + \text{NH}_3 \rightarrow \text{Mg}_3\text{N}_2 + \text{H}_2$$
- (a) $\frac{200}{3}$
(b) $\frac{100}{3}$
(c) $\frac{400}{3}$
(d) $\frac{150}{3}$

02 Mole Concept

- Q6. What is the maximum amount of nitrogen dioxide that can be produced by mixing 4.2 gm of NO(g) and 3.2 gm of O₂(g)?
- 4.60g
 - 2.30g
 - 3.22g
 - 6.44g
- Q7. Which has maximum moles number of atoms?
- 24g of C(12)
 - 56g of Fe(56)
 - 27g of Al(27)
 - 108g of Ag(108)
- Q8. Equal volumes of 10% (v/v) of HCl solution. If density of pure NaOH is 1.5 times that of pure HCl then the resultant solution be.
- basic
 - neutral
 - acidic
 - can't be predicted.
- Q9. Given that the abundances of isotopes ⁵⁴Fe, ⁵⁶Fe and ⁵⁷Fe are 5%, 90% and 5%, respectively, the atomic mass of Fe is
- 55.85
 - 55.95
 - 55.75
 - 56.05
- Q10. 100 mL of 30% (w/v) NaOH solution is mixed with 100 mL 90% (w/v) NaOH solution. Find the molarity of final solution.
- 1.3
 - 13
 - 1/5
 - 15



Answer & Solution

ANSWER

Q1	Q2	Q3	Q4	Q5
(b)	(a)	(d)	(c)	(a)
Q6	Q7	Q8	Q9	Q10
(d)	(a)	(a)	(b)	(d)

miso
study

JEE Advanced Pattern Exercise (1)

- Q1. Dissolving 120 g of urea (mol. wt. 60) in 1000 g of water gave a solution of density 1.15 g/mL. The molarity of the solution is
- 1.78M
 - 2.00M
 - 2.05M
 - 2.22M

Paragraph question

FeSO₄ undergoes decomposition as

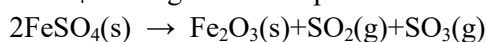

At 1 atm & 273 K if (7.6 gm) FeSO₄ is taken then.

- Q2. The volume occupied by the gases at 1 atm & 273K.
- 22.4 lit
 - 11.2 lit
 - 1.12 lit
 - 2.24 lit
- Q3. The average molar mass of the gaseous mixture.
- 72
 - 36
 - 48
 - 60

Assertion and Reason

- Both Statement I and Statement II are correct; Statement II is the correct explanation of Statement I
 - Both Statement I and Statement II are correct; Statement II is not the correct explanation of Statement I
 - Statement I is correct; Statement II is incorrect
 - Statement I is incorrect; Statement II is correct
- Q4. **Statement I** : Molality of pure ethanol is lesser than pure water.
Statement II : As density of ethanol is lesser than density of water.
[Given : $d_{\text{ethanol}} = 0.789 \text{ gm/ml}$; $d_{\text{water}} = 1 \text{ gm/ml}$]
- Q5. **Statement I** : A one molal solution prepared at 20°C will retain the same molality at 100°C, provided there is no loss of solute or solvent on heating.
Statement II : Molality is independent of temperatures.

02 Mole Concept

- Q6. A mixture of C_3H_8 (g) O_2 having total volume 100 ml in an Eudiometry tube is sparked & it is observed that a contraction of 45 ml is observed what can be the composition of reacting mixture.
- 15 ml C_3H_8 & 85 ml O_2
 - 25 ml C_3H_8 & 75 ml O_2
 - 45 ml C_3H_8 & 55 ml O_2
 - 55 ml C_3H_8 & 45 ml O_2

- Q7. Which has the maximum number of atoms :
- 24 g C
 - 56 g Fe
 - 27 g Al
 - 108 g Ag (108)

- Q8. Match the column:

Column I

- 16 g of CH_4
- 1 g of H_2
- 22 g of CO_2
- 9 g of H_2O

Column II

- $1/2$ mole molecule
- $6.023 \times 10^{23} \times 5$ atoms
- 11.2 litre
- 1.806×10^{23} atoms

- Q9. A 5.2 molal aqueous solution of methyl alcohol, CH_3OH , is supplied. What is the mole fraction of methyl alcohol in the solution
- 0.100
 - 0.190
 - 0.086
 - 0.050
- Q10. A compound H_2X with molar weight of 80 g is dissolved in a solvent having density of 0.4 g mL^{-1} . Assuming no change in volume upon dissolution, the molality of a 3.2 molar solution is



Answer & Solution

ANSWER

Q1	Q2	Q3	Q4	Q5
(c)	(c)	(a)	(b)	(a)
Q6	Q7	Q8	Q9	Q10
(a), (b)	(a)	(A) - Q (B) - P, R (C) - P, R (D) - P	(c)	8

JEE

MATHEMATICS

- ▶ Specially designed eBook for complete JEE syllabus
- ▶ JEE preparation strategy & direction, speedy revision
- ▶ Chapter-wise important Problem-Solving
- ▶ Theory, Formulas & Diagrams to crack JEE
- ▶ Detailed high quality video lectures by experienced faculties
- ▶ JEE full preparation for Class XI & XII



misostudy
connect smart learning

JEE·NEET·AIIMS·CBSE·FOUNDATION
www.misostudy.com

☎ 8929803804 (MON-FRI: 9am-6pm) support@misostudy.com

MISO STUDY INDIA PVT. LTD.
2ND FLOOR 65-A, OMPRO TOWER, KALU SARAI, NEW DELHI, DELHI 110016

Geometric Representation

Class 11 | Mathematics

03 Sets

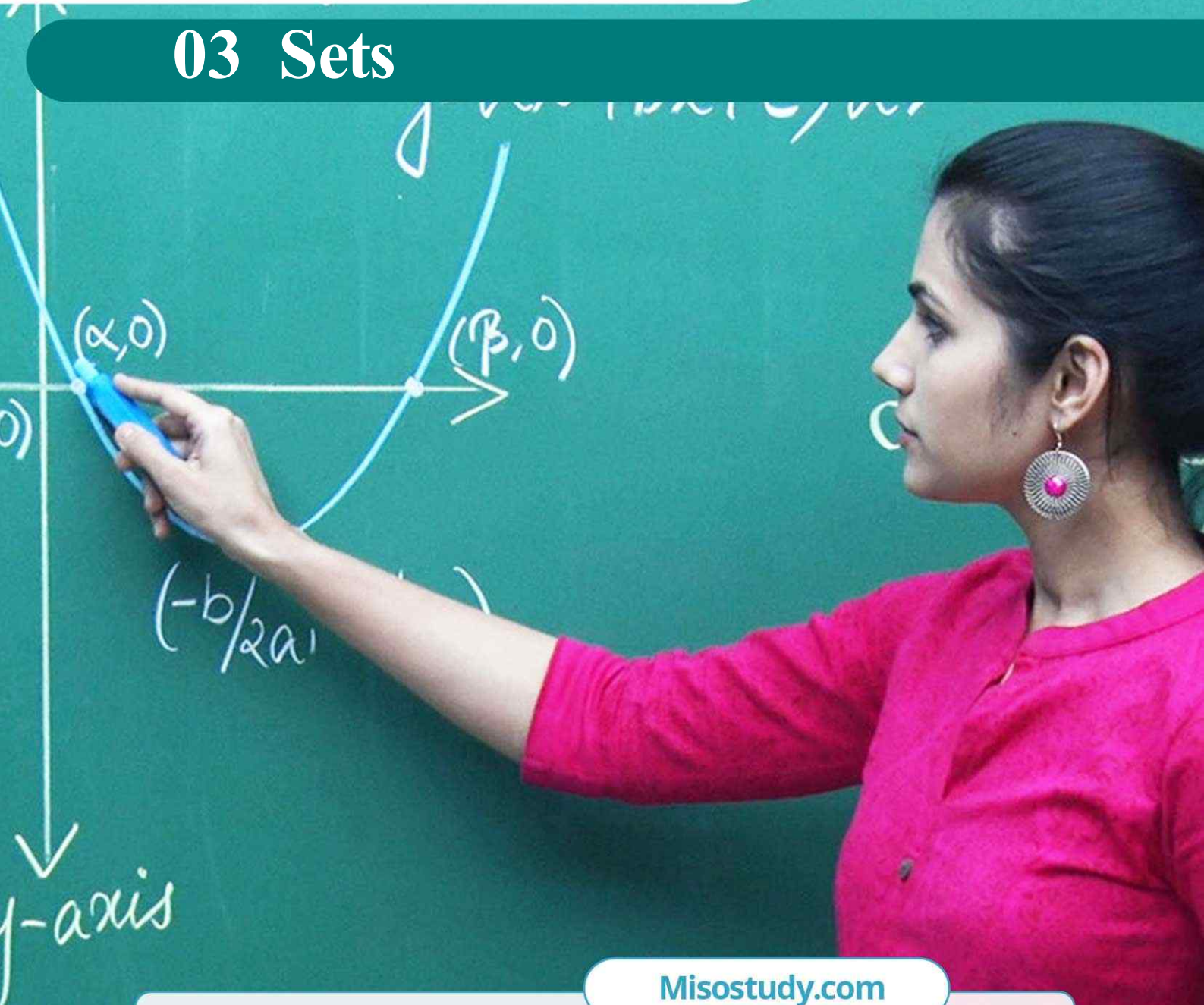

Misostudy.com



Scientific eBook

This is a sample eBook. The eBook provides chapter-wise theories and examples, formulas, diagrams, and Exam pattern Problem-Solving of the full syllabus.



Complete video lectures

The theory and Problem-Solving in this eBook provide specially designed the video lectures by experienced faculties. Get Free trial and preview on Misostudy.com.

01. Definition of Set

Set as “a well defined collection of objects”.

Example The collection of vowels in English alphabets. This set contains five elements, namely, a, e, i, o, u.

NOTE  Collection of good teachers in a school is not a set.

02. Reserved Symbols

We reserve some symbols for these set:

- ① **N** : for the set of natural numbers.
- ② **Z** : for the set of integers.
- ③ **Z⁺** : for the set of all positive integers.
- ④ **Q** : for the set of all rational numbers.
- ⑤ **Q⁺** : for the set of all positive rational numbers.
- ⑥ **R** : for the set of all real numbers.
- ⑦ **R⁺** : for the set of all positive real numbers.
- ⑧ **C** : for the set of all complex numbers.

03. Description of a Set

A set is often described in the following two forms. One can make use of any one of these two ways according to his (her) convenience.

- (i) Roster form or Tabular form
- (ii) Set-builder form

ROSTER FORM

In this form a set is described by listing elements, separated by commas, within braces {}.

NOTE  (1) The order in which the elements are written in a set makes no difference.
(2) Also, the repetition of an element has no effect.

SET-BUILDER FORM

In this form, a set is described by a characterizing property $P(x)$ of its elements x . In such a case the set is described by $\{x : P(x) \text{ holds}\}$ or, $\{x | P(x) \text{ holds}\}$, which is read as 'the set of all x such that $P(x)$ holds'. The symbol '|' or ':' is read as 'such that'.

04. Types of Sets

- (1) **EMPTY SET** A set is said to be empty or null or void set if it has no element and it is denoted by ϕ (phi).
In Roster method, ϕ is denoted by $\{\}$.
- (2) **SINGLETON SET** A set consisting of a single element is called a singleton set.
- (3) **FINITE SET** A set is called a finite set if it is either void set or its elements can be listed (counted, labelled) by natural numbers 1, 2, 3, ... and the process of listing terminates at a certain natural number n (say).
- (4) **CARDINAL NUMBER OF A FINITE SET** The number n in the above definition is called the cardinal number or order of a finite set A and is denoted by $n(A)$.
- (5) **INFINITE SET** A set whose elements cannot be listed by the natural numbers 1, 2, 3, ..., n , for any natural number n is called an infinite set.
- (6) **EQUIVALENT SETS** Two finite sets A and B are equivalent if their cardinal numbers are same i.e. $n(A) = n(B)$.
- (7) **EQUAL SETS** Two sets A and B are said to be equal if every element of A is a member of B , and every element of B is a member of A .

05. Subsets

Let A and B be two sets. If every element of A is an element of B , then A is called a subset of B .

If A is a subset of B , we write $A \subseteq B$, which is read as " A is a subset of B " or " A is contained in B ".

Thus, $A \subseteq B$ if $a \in A \Rightarrow a \in B$.

SOME RESULTS ON SUBSETS

RESULT 1 Every set is a subset of itself.

RESULT 2 The empty set is a subset of every set.

RESULT 3 The total number of subsets of a finite set containing n elements is 2^n .

REMARK

SUBSETS OF THE SET \mathbf{R} OF REAL NUMBERS

i) The set of all natural numbers $N = \{1, 2, 3, 4, 5, 6, \dots\}$

ii) The set of all integers $Z = \{\dots, -3, -2, -1, 0, 1, 2, 3, \dots\}$

iii) The set of all rational numbers $Q = \{x : x = \frac{m}{n}, m, n \in Z, n \neq 0\}$.

iv) The set of all irrational numbers. It is denoted by T .

Thus,

$$T = \{x : x \in R \text{ and } x \notin Q\}$$

Clearly, $N \subset Z \subset Q \subset R$, $T \subset R$ and $N \not\subset T$.

06. Universal Set

A set that contains all sets in a given context is called the universal set.

Example If $A = \{1, 2, 3\}$, $B = \{2, 4, 5, 6\}$ and $C = \{1, 3, 5, 7\}$, then $U = \{1, 2, 3, 4, 5, 6, 7\}$ can be taken as the universal set.

07. Power Set

Let A be a set. Then the collection or family of all subsets of A is called the power set of A and is denoted by $P(A)$. The power set of a given set is always non-empty.

Example Let $A = \{1, 2, 3\}$. Then, the subsets of A are:
 $\phi, \{1\}, \{2\}, \{3\}, \{1, 2\}, \{1, 3\}, \{2, 3\}$, and $\{1, 2, 3\}$.
 Hence, $P(A) = \{\phi, \{1\}, \{2\}, \{3\}, \{1, 2\}, \{1, 3\}, \{2, 3\}, \{1, 2, 3\}\}$.

08. Venn Diagrams

In Venn-diagrams the universal set U is represented by points within a rectangle and its subsets are represented by points in closed curves (usually circles) within the rectangle.

A set containing other set

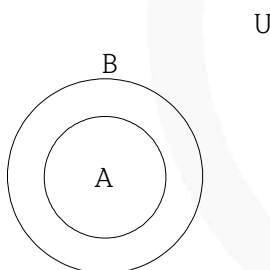

Intersecting sets

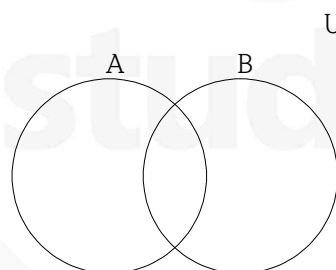

Non intersecting sets

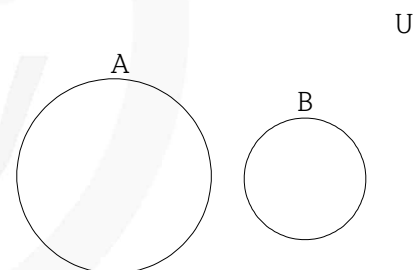

09. Operations On Sets

(1) UNION OF SETS

Let A and B be two sets. The union of A and B is the set of all those elements which belong either to A or to B or to both A and B .

We shall use the notation $A \cup B$ (read as “ A union B ”) to denote the union of A and B .

Thus, $A \cup B = \{x : x \in A \text{ or } x \in B\}$.

(2) INTERSECTION OF SETS

Let A and B be two sets. The intersection of A and B is the set of all those elements that belong to both A and B .

The intersection of A and B is denoted by $A \cap B$ (read as “ A intersection B ”)

Thus, $A \cap B = \{x : x \in A \text{ and } x \in B\}$.

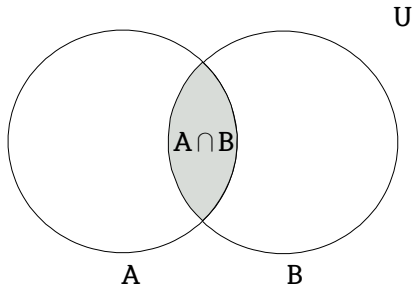
**(3) DISJOINT SETS**

Two sets A and B are said to be disjoint, if $A \cap B = \phi$.

If $A \cap B \neq \phi$, then A and B said to be intersecting or overlapping sets.

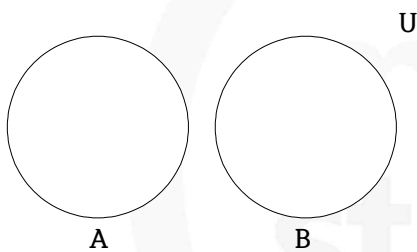
**(4) DIFFERENCE OF SETS**

Let A and B be two sets. The difference of A and B , written as $A - B$, is the set of all those elements of A which do not belong to B .

Thus, $A - B = \{x : x \in A \text{ and } x \notin B\}$

or, $A - B = \{x \in A : x \notin B\}$

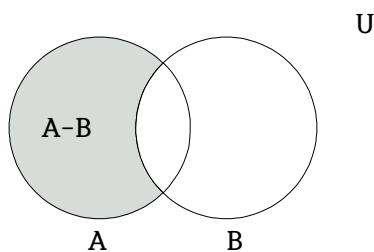

Similarly, the difference $B - A$ is the set of all those elements of B that do not belong to A i.e.

$$B - A = \{x \in B : x \notin A\}.$$

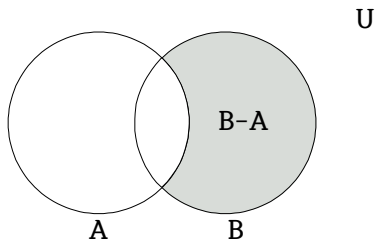

(5) SYMMETRIC DIFFERENCE OF TWO SETS

Let A and B be two sets. The symmetric difference of sets A and B is the set $(A - B) \cup (B - A)$ and is denoted by $A \Delta B$.

$$\text{Thus, } A \Delta B = (A - B) \cup (B - A) = \{x : x \notin A \cap B\}$$

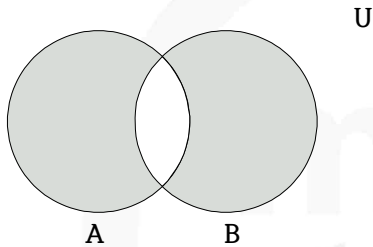

(6) COMPLEMENT OF A SET

Let U be the universal set and let A be a set such that $A \subset U$. Then, the complement of A with respect to U is denoted by A' or A^c or $U - A$ and is defined the set of all those elements of U which are not in A .

$$\text{Thus } A' = \{x \in U : x \notin A\}.$$

$$\text{Clearly, } x \in A' \Leftrightarrow x \notin A.$$

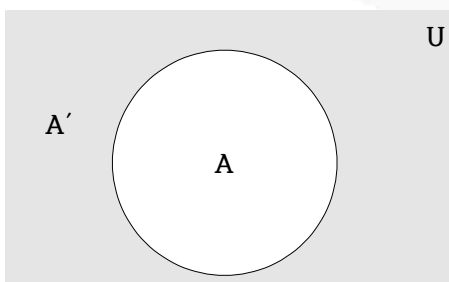

10. Laws of Algebra of Sets

RESULT 1 (Idempotent Laws) For any set A , we have

(i) $A \cup A = A$

PROOF

$$A \cup A = \{x : x \in A \text{ or } x \in A\} = \{x : x \in A\} = A$$

$$A \cap A = A.$$

$$A \cap A = \{x : x \in A \text{ and } x \in A\} = \{x : x \in A\} = A.$$

RESULT 2 (identity Laws) For any set A , we have

(i) $A \cup \phi = A$

i.e. ϕ and U are identity elements for union and intersection respectively.

PROOF

$$A \cup \phi = \{x : x \in A \text{ or } x \in \phi\} = \{x : x \in A\} = A$$

(ii) $A \cap U = A.$

$$A \cap U = \{x : x \in A \text{ and } x \in U\} = \{x : x \in A\} = A$$

RESULT 3 (Commutative Laws) For any two sets A and B , we have

(i) $A \cup B = B \cup A$

i.e. union and intersection are commutative.

PROOF

Recall that two sets X and Y are equal iff $X \subseteq Y$ and $Y \subseteq X$. Also, $X \subseteq Y$ if every element of X belongs to Y .

Let x be an arbitrary element of $A \cup B$. Then,

$$x \in A \cup B \Rightarrow x \in A \text{ or } x \in B \Rightarrow x \in B \text{ or } x \in A \Rightarrow x \in B \cup A$$

$$\therefore A \cup B \subseteq B \cup A.$$

Similarly, $B \cup A \subseteq A \cup B$.

Hence, $A \cup B = B \cup A$.

(ii) $A \cap B = B \cap A$

Let x be an arbitrary element of $A \cap B$.

Then, $x \in A \cap B \Rightarrow x \in A$ and $x \in B$

$$\Rightarrow x \in B \text{ and } x \in A \Rightarrow x \in B \cap A$$

$$\therefore A \cap B \subseteq B \cap A$$

Similarly, $B \cap A \subseteq A \cap B$

Hence, $A \cap B = B \cap A$.

RESULT 4 (Associative Laws) If A , B and C are any three sets, then

(i) $(A \cup B) \cup C = A \cup (B \cup C)$

i.e. union and intersection are associative.

PROOF

Let x be an arbitrary element of $(A \cup B) \cup C$. Then,

$$\begin{aligned} & x \in (A \cup B) \cup C \\ \Rightarrow & x \in (A \cup B) \text{ or } x \in C \\ \Rightarrow & (x \in A \text{ or } x \in B) \text{ or } x \in C \\ \Rightarrow & x \in A \text{ or } (x \in B \text{ or } x \in C) \\ \Rightarrow & x \in A \text{ or } x \in (B \cup C) \\ \Rightarrow & x \in A \cup (B \cup C) \\ \therefore & (A \cup B) \cup C \subseteq A \cup (B \cup C). \end{aligned}$$

Similarly, $A \cup (B \cup C) \subseteq (A \cup B) \cup C$.

Hence, $(A \cup B) \cup C = A \cup (B \cup C)$.

$$(ii) \quad A \cap (B \cap C) = (A \cap B) \cap C$$

Let x be an arbitrary element of $A \cap (B \cap C)$. Then,

$$\begin{aligned} & x \in A \cap (B \cap C) \\ \Rightarrow & x \in A \text{ and } x \in (B \cap C) \\ \Rightarrow & x \in A \text{ and } (x \in B \text{ and } x \in C) \\ \Rightarrow & (x \in A \text{ and } x \in B) \text{ and } x \in C \\ \Rightarrow & x \in (A \cap B) \text{ and } x \in C \\ \Rightarrow & x \in (A \cap B) \cap C \\ \therefore & A \cap (B \cap C) \subseteq (A \cap B) \cap C. \end{aligned}$$

Similarly, $(A \cap B) \cap C \subseteq A \cap (B \cap C)$.

Hence, $A \cap (B \cap C) = (A \cap B) \cap C$.

RESULT 5 (Distributive Laws) If A , B and C are any three sets, then

$$(i) \quad A \cup (B \cap C) = (A \cup B) \cap (A \cup C)$$

i.e. union and intersection are distributive over intersection and union respectively.

PROOF

Let x be an arbitrary element of $A \cup (B \cap C)$. Then,

$$\begin{aligned} & x \in A \cup (B \cap C) \\ \Rightarrow & x \in A \text{ or } x \in (B \cap C) \\ \Rightarrow & x \in A \text{ or } (x \in B \text{ and } x \in C) \\ \Rightarrow & (x \in A \text{ or } x \in B) \text{ and } (x \in A \text{ or } x \in C) \quad [\because \text{'or' is distributive over 'and'}] \\ \Rightarrow & x \in (A \cup B) \text{ and } x \in (A \cup C) \\ \Rightarrow & x \in ((A \cup B) \cap (A \cup C)) \\ \therefore & A \cup (B \cap C) \subseteq (A \cup B) \cap (A \cup C) \end{aligned}$$

Similarly, $(A \cup B) \cap (A \cup C) \subseteq A \cup (B \cap C)$.

Hence, $A \cup (B \cap C) = (A \cup B) \cap (A \cup C)$.

$$(ii) A \cup (B \cap C) = (A \cap B) \cup (A \cap C).$$

Let x be an arbitrary element of $A \cap (B \cup C)$. Then,

$$\begin{aligned} & x \in A \cap (B \cup C) \\ \Rightarrow & x \in A \text{ and } x \in (B \cup C) \\ \Rightarrow & x \in A \text{ and } (x \in B \text{ or } x \in C) \\ \Rightarrow & (x \in A \text{ and } x \in B) \text{ or } (x \in A \text{ and } x \in C) \\ \Rightarrow & x \in (A \cap B) \text{ or } x \in (A \cap C) \\ \Rightarrow & x \in (A \cap B) \cup (A \cap C) \\ \therefore & A \cap (B \cup C) \subseteq (A \cap B) \cup (A \cap C) \end{aligned}$$

Similarly, $(A \cap B) \cup (A \cap C) \subseteq A \cap (B \cup C)$.

Hence, $A \cap (B \cup C) = (A \cap B) \cup (A \cap C)$.

RESULT 6 (De-morgan's Laws) If A and B are any two sets, then

$$(i) (A \cup B)' = A' \cap B'$$

PROOF

Let x be an arbitrary element of $(A \cup B)'$. Then,

$$\begin{aligned} & x \in (A \cup B)' \\ \Rightarrow & x \notin (A \cup B) \\ \Rightarrow & x \notin A \text{ and } x \notin B \\ \Rightarrow & x \in A' \text{ and } x \in B' \\ \Rightarrow & x \in A' \cap B'. \\ \therefore & (A \cup B)' \subseteq A' \cap B'. \end{aligned}$$

Again, let y be an arbitrary element of $A' \cap B'$. Then,

$$\begin{aligned} & y \in A' \cap B' \\ \Rightarrow & y \in A' \text{ and } y \in B' \\ \Rightarrow & y \notin A \text{ and } y \notin B \\ \Rightarrow & y \notin A \cup B. \\ \Rightarrow & y \in (A \cup B)' \\ \therefore & A' \cap B' \subseteq (A \cup B)'. \end{aligned}$$

Hence, $(A \cup B)' = A' \cap B'$

$$(ii) (A \cap B)' = A' \cup B'$$

Let x be an arbitrary element of $(A \cap B)'$. Then,

$$\begin{aligned} & x \in (A \cap B)' \\ \Rightarrow & x \notin (A \cap B) \\ \Rightarrow & x \notin A \text{ or } x \notin B \\ \Rightarrow & x \in A' \text{ or } x \in B' \\ \Rightarrow & x \in A' \cup B' \\ \Rightarrow & (A \cap B)' \subseteq A' \cup B'. \end{aligned}$$

Again, let y be an arbitrary element of $A' \cup B'$. Then,

$$\begin{aligned} & y \in (A' \cap B') \\ \Rightarrow & y \in A' \text{ or } y \in B' \\ \Rightarrow & y \notin A \text{ or } y \notin B \\ \Rightarrow & y \notin (A \cap B) \\ \Rightarrow & y \in (A \cap B)' \\ \therefore & A' \cup B' \subseteq (A \cap B)' \\ \text{Hence, } & (A \cap B)' = A' \cup B'. \end{aligned}$$

11. MORE RESULTS ON OPERATIONS ON SETS

RESULT 1 If A and B are any two sets, then

$$(i) \quad A - B = A \cap B'$$

PROOF

Let x be an arbitrary element of $A - B$. Then,

$$\begin{aligned} & x \in (A - B) \\ \Rightarrow & x \in A \text{ and } x \notin B \\ \Rightarrow & x \in A \text{ and } x \notin B' \\ \Rightarrow & x \in A \cap B' \\ \therefore & A - B \subseteq A \cap B' \end{aligned} \quad \dots(i)$$

Again, let y be an arbitrary element of $A \cap B'$. Then,

$$\begin{aligned} & y \in A \cap B' \\ \Rightarrow & y \in A \text{ and } y \in B' \\ \Rightarrow & y \in A \text{ and } y \notin B \\ \Rightarrow & y \in A - B \\ \therefore & A \cap B' \subseteq (A - B) \end{aligned} \quad \dots(ii)$$

Hence, from (i) and (ii), we have $A - B = A \cap B'$.

$$(ii) \quad B - A = B \cap A'$$

Let x be an arbitrary element of $B - A$. Then,

$$\begin{aligned} & x \in B - A \\ \Rightarrow & x \in B \text{ and } x \notin A \\ \Rightarrow & x \in B \text{ and } x \in A^c \\ \Rightarrow & x \in B \cap A^c \\ \therefore & B - A \subseteq B \cap A^c \end{aligned} \quad \dots(i)$$

Again, let y be an arbitrary element of $B \cap A^c$

$$\begin{aligned} \Rightarrow & y \in B \text{ and } y \in A^c \\ \Rightarrow & y \in B \text{ and } y \notin A \\ \Rightarrow & y \in B - A \\ \therefore & B \cap A^c \subseteq (B - A) \end{aligned} \quad \dots(ii)$$

Hence, from (i) and (ii), we have $B - A = B \cap A^c$.

$$(iii) \quad A - B = A \Leftrightarrow A \cap B = \phi$$

In order to prove that $A - B = A \Leftrightarrow A \cap B = \phi$

we shall prove that:

$$(i) \quad A - B = A \Rightarrow A \cap B = \phi,$$

$$(ii) \quad A \cap B = \phi \Rightarrow A - B = A.$$

First, let $A - B = A$. Then we have to prove that $A \cap B = \phi$. If possible, let $A \cap B \neq \phi$. Then,

$$\begin{aligned} A \cap B \neq \phi &\Rightarrow \text{there exists } x \in A \cap B \\ &\Rightarrow x \in A \text{ and } x \in B \Rightarrow x \in A - B \text{ and } x \in B \quad [\because A - B = A] \\ &\Rightarrow (x \in A \text{ and } x \notin B) \text{ and } x \in B \quad [\text{By def. of } A - B] \\ &\Rightarrow x \in A \text{ and } (x \notin B \text{ and } x \in B) \end{aligned}$$

But $x \notin B$ and $x \in B$ both can never be possible simultaneously. Thus, we arrive at a contradiction, So, our supposition is wrong.

$$\therefore \quad A \cap B = \phi$$

$$\text{Hence, } A - B = A \Rightarrow A \cap B = \phi \quad \dots(i)$$

Conversely, let $A \cap B = \phi$. Then we have to prove that $A - B = A$. For this we shall show that $A - B \subseteq A$ and $A \subseteq A - B$

Let x be an arbitrary element of $A - B$. Then,

$$\begin{aligned} x \in A - B &\Rightarrow x \in A \text{ and } x \notin B \\ &\Rightarrow x \in A \end{aligned}$$

$$\therefore \quad A - B \subseteq A.$$

Again let y be an arbitrary element of A . Then,

$$\begin{aligned} y \in A &\Rightarrow y \in A \text{ and } y \notin B \quad [\because A \cap B = \phi] \\ &\Rightarrow y \in A - B \quad [\text{By def. of } A - B] \end{aligned}$$

$$\therefore \quad A \subseteq A - B.$$

So, we have $A - B \subseteq A$ and $A \subseteq A - B$. Therefore, $A - B = A$.

$$\text{Thus, } A \cap B = \phi \Rightarrow A - B = A \quad \dots(ii)$$

Hence, from (i) and (ii), we have

$$A - B = A \Leftrightarrow A \cap B = \phi.$$

$$(iv) \quad (A - B) \cup B = A \cup B$$

Let x be an arbitrary element of $(A - B) \cup B$. Then,

$$\begin{aligned} x \in (A - B) \cup B \\ \Rightarrow x \in A - B \text{ or } x \in B \\ \Rightarrow (x \in A \text{ and } x \notin B) \text{ or } x \in B \\ \Rightarrow (x \in A \text{ or } x \in B) \text{ and } (x \notin B \text{ or } x \in B) \\ \Rightarrow x \in A \cup B \\ \therefore (A - B) \cup B \subseteq A \cup B \end{aligned}$$

Let y be an arbitrary element of $A \cup B$. Then,

$$\begin{aligned} y \in A \cup B \\ \Rightarrow y \in A \text{ or } y \in B \\ \Rightarrow (y \in A \text{ or } y \in B) \text{ and } (y \notin B \text{ or } y \in B) \\ \Rightarrow (y \in A \text{ and } y \notin B) \text{ or } y \in B \\ \Rightarrow y \in (A - B) \cup B \\ \therefore A \cup B \subseteq (A - B) \cup B \end{aligned}$$

$$\text{Hence, } (A - B) \cup B = A \cup B.$$

$$(v) \quad (A-B) \cap B = \phi$$

If possible let $(A-B) \cap B \neq \phi$. Then, there exists at least one element x , (say), in $(A-B) \cap B$.

$$\begin{aligned} \text{Now, } x \in (A-B) \cap B &\Rightarrow x \in (A-B) \text{ and } x \in B \\ &\Rightarrow (x \in A \text{ and } x \notin B) \text{ and } x \in B \\ &\Rightarrow x \in A \text{ and } (x \notin B \text{ and } x \in B) \end{aligned}$$

But, $x \notin B$ and $x \in B$ both can never be possible simultaneously. Thus, we arrive at a contradiction.

So, our supposition is wrong.

$$\text{Hence, } (A-B) \cap B = \phi$$

$$(vi) \quad A \subseteq B \Leftrightarrow B' \subseteq A'$$

First, let $A \subseteq B$. Then we have to prove that $B' \subseteq A'$. Let x be an arbitrary element of B' . Then,

$$\begin{aligned} x \in B' &\Rightarrow x \notin B \\ &\Rightarrow x \notin A && [\because A \subseteq B] \\ &\Rightarrow x \in A' \end{aligned}$$

$$\therefore B' \subseteq A'$$

$$\text{Thus, } A \subseteq B \Rightarrow B' \subseteq A' \quad \dots(i)$$

Conversely, let $B' \subseteq A'$. Then, we have to prove that $A \subseteq B$. Let y be an arbitrary element of A . Then,

$$\begin{aligned} y \in A &\Rightarrow y \notin A' \\ &\Rightarrow y \notin B' && [\because B' \subseteq A'] \\ &\Rightarrow y \in B \end{aligned}$$

$$\therefore A \subseteq B$$

$$\text{Thus, } B' \subseteq A' \Rightarrow A \subseteq B \quad \dots(ii)$$

From (i) and (ii), we have $A \subseteq B \Leftrightarrow B' \subseteq A'$.

$$(vii) \quad (A-B) \cup (B-A) = (A \cup B) - (A \cap B)$$

Let x be an arbitrary element of $(A-B) \cup (B-A)$. Then,

$$\begin{aligned} x \in (A-B) \cup (B-A) \\ \Rightarrow x \in A-B \text{ or } x \in B-A \\ \Rightarrow (x \in A \text{ and } x \notin B) \text{ or } (x \in B \text{ and } x \notin A) \\ \Rightarrow (x \in A \text{ or } x \in B) \text{ and } (x \notin B \text{ or } x \notin A) \\ \Rightarrow x \in (A \cup B) \text{ and } x \notin (A \cap B) \\ \Rightarrow x \in (A \cup B) - (A \cap B) \\ \therefore (A-B) \cup (B-A) \subseteq (A \cup B) - (A \cap B) \quad \dots(i) \end{aligned}$$

Again, let y be an arbitrary element of $(A \cup B) - (A \cap B)$.

$$\begin{aligned} \text{Thus, } y \in (A \cup B) - (A \cap B) \\ \Rightarrow y \in A \cup B \text{ and } y \notin A \cap B \\ \Rightarrow (y \in A \text{ or } y \in B) \text{ and } (y \notin A \text{ and } y \notin B) \\ \Rightarrow (y \in A \text{ and } y \notin B) \text{ or } (y \in B \text{ and } y \notin A) \\ \Rightarrow y \in (A-B) \text{ or } y \in (B-A) \Rightarrow y \in (A-B) \cup (B-A). \\ \therefore (A \cup B) - (A \cap B) \subseteq (A-B) \cup (B-A) \quad \dots(ii) \end{aligned}$$

Hence, from (i) and (ii), we have

$$(A-B) \cup (B-A) = (A \cup B) - (A \cap B).$$

RESULT 2 If A , B and C are any three sets, then prove that:

(i) $A - (B \cap C) = (A - B) \cup (A - C)$

PROOF

Let x be any element of $A - (B \cap C)$. Then,

$$\begin{aligned} x \in A - (B \cap C) &\Rightarrow x \in A \text{ and } x \notin (B \cap C) \\ &\Rightarrow x \in A \text{ and } (x \notin B \text{ or } x \notin C) \\ &\Rightarrow (x \in A \text{ and } x \notin B) \text{ or } (x \in A \text{ and } x \notin C) \\ &\Rightarrow x \in (A - B) \text{ or } x \in (A - C) \\ &\Rightarrow x \in (A - B) \cup (A - C) \end{aligned}$$

$$\therefore A - (B \cap C) \subseteq (A - B) \cup (A - C)$$

Similarly, $(A - B) \cup (A - C) \subseteq A - (B \cap C)$

Hence, $A - (B \cap C) = (A - B) \cup (A - C)$

(ii) $A - (B \cup C) = (A - B) \cap (A - C)$

Let x be an arbitrary element of $A - (B \cup C)$. Then

$$\begin{aligned} x \in A - (B \cup C) &\Rightarrow x \in A \text{ and } x \notin (B \cup C) \\ &\Rightarrow x \in A \text{ and } (x \notin B \text{ and } x \notin C) \\ &\Rightarrow (x \in A \text{ and } x \notin B) \text{ and } (x \in A \text{ and } x \notin C) \\ &\Rightarrow x \in (A - B) \text{ and } x \in (A - C) \\ &\Rightarrow x \in (A - B) \cap (A - C) \end{aligned}$$

$$\therefore A - (B \cup C) \subseteq (A - B) \cap (A - C)$$

Similarly, $(A - B) \cap (A - C) \subseteq A - (B \cup C)$

Hence, $A - (B \cup C) = (A - B) \cap (A - C)$

(iii) $A \cap (B - C) = (A \cap B) - (A \cap C)$

Let x be any arbitrary element of $A \cap (B - C)$. Then

$$\begin{aligned} x \in A \cap (B - C) &\Rightarrow x \in A \text{ and } x \in (B - C) \\ &\Rightarrow x \in A \text{ and } (x \in B \text{ and } x \notin C) \\ &\Rightarrow (x \in A \text{ and } x \in B) \text{ and } (x \in A \text{ and } x \notin C) \\ &\Rightarrow x \in (A \cap B) \text{ and } x \notin (A \cap C) \\ &\Rightarrow x \in (A \cap B) - (A \cap C) \end{aligned}$$

$$\therefore A \cap (B - C) \subseteq (A \cap B) - (A \cap C)$$

Similarly, $(A \cap B) - (A \cap C) \subseteq A \cap (B - C)$

Hence, $A \cap (B - C) = (A \cap B) - (A \cap C)$.

(iv) $A \cap (B \Delta C) = (A \cap B) \Delta (A \cap C)$

$$\begin{aligned} A \cap (B \Delta C) &= A \cap [(B - C) \cup (C - B)] \\ &= [A \cap (B - C)] \cup [A \cap (C - B)] && \text{[By distributive law]} \\ &= [(A \cap B) - (A \cap C)] \cup [(A \cap C) - (A \cap B)] && \text{[Using (iii)]} \\ &= (A \cap B) \Delta (A \cap C) \end{aligned}$$

12. SOME IMPORTANT RESULTS ON NUMBER OF ELEMENTS IN SETS

If A, B and C are finite sets, and U be the finite universal set, then

(i) $n(A \cup B) = n(A) + n(B) - n(A \cap B)$

(ii) $n(A \cup B) = n(A) + n(B) \Leftrightarrow A, B$ are disjoint non-void sets.

(iii) $n(A - B) = n(A) - n(A \cap B)$ i.e. $n(A - B) + n(A \cap B) = n(A)$

(iv) $n(A \triangle B) =$ No. of elements which belong to exactly one of A or B

$$= n((A - B) \cup (B - A))$$

$$= n(A - B) + n(B - A) \quad [\because (A - B) \text{ and } (B - A) \text{ are disjoint}]$$

$$= n(A) - n(A \cap B) + n(B) - n(A \cap B)$$

$$= n(A) + n(B) - 2n(A \cap B)$$

(v) $n(A \cup B \cup C) = n(A) + n(B) + n(C) - n(A \cap B) - n(B \cap C) - n(A \cap C) + n(A \cap B \cap C)$

(vi) No. of elements in exactly two of the sets A, B, C

$$= n(A \cap B) + n(B \cap C) + n(C \cap A) - 3n(A \cap B \cap C).$$

(vii) No. of elements in exactly one of the sets A, B, C

$$= n(A) + n(B) + n(C) - 2n(A \cap B) - 2n(B \cap C) - 2n(A \cap C) + 3n(A \cap B \cap C)$$

(viii) $n(A' \cup B') = n((A \cap B)') = n(U) - n(A \cap B)$

(ix) $n(A' \cap B') = n((A \cup B)') = n(U) - n(A \cup B).$

JEE Main Pattern Exercise (1)

- Q1. For two events A and B which of the following is simple expression of $(A \cap B) \cup (A \cap B') \cup (A' \cap B)$?
- (a) $(A \cap B)$
 (b) $(A \cup B)$
 (c) $(A' \cap B')$
 (d) $(A \cap B')$
- Q2. If $U = \{1, 2, 3\}$ and $A = \{1, 2\}$ then $[P(A)]' =$ _____
- (a) $\{\{3\}, \{2, 3\}, \{1, 3\}, \{1, 2\}, \phi\}$
 (b) $\{\{3\}, \{2, 3\}, \{1, 3\}, \{1, 2, 3\}\}$
 (c) $\{\{3\}, \{2, 3\}, \{1, 3\}, \{1, 2, 3\}, \phi\}$
 (d) $\{\{3\}, \{2, 3\}, \{1, 3\}, \{1, 2\}\}$
- Q3. Let U be the universal set and $A \cup B \cup C = U$. Then $[(A - B) \cup (B - C) \cup (C - A)]'$ equals
- (a) $A \cup B \cup C$
 (b) $A \cap B \cap C$
 (c) $A \cup (B \cap C)$
 (d) $A \cap (B \cup C)$
- Q4. The set $(A \cup B \cup C) \cap (A \cap B' \cap C')' \cap C'$ equals
- (a) $B \cap C'$
 (b) $B \cup C'$
 (c) $A \cap C$
 (d) $A \cup C$
- Q5. Let $A = \{(x, y) : y = e^x, x \in R\}$, $B = \{(x, y) : y = e^{-x}, x \in R\}$, then
- (a) $A \cap B = \phi$
 (b) $A \cap B \neq \phi$
 (c) $A \cup B = R$
 (d) $A \cup B = A$
- Q6. Let U be the universal set containing 700 elements. If A, B are sub-sets of U such that $n(A) = 200, n(B) = 300$ and $n(A \cap B) = 100$. Then, $n(A' \cap B') =$
- (a) 400
 (b) 600
 (c) 300
 (d) none of these

- Q7. If $A = \{1, 2, 3, 4, 5\}$, then the number of proper subset of A is
- (a) 120
 - (b) 30
 - (c) 31
 - (d) 32
- Q8. If A and B are two sets then $B - (B - A) =$ _____
- (a) $(A - B) - B$
 - (b) $A - (A - B)$
 - (c) A
 - (d) B
- Q9. Taking $U = [1, 5]$, $A = \{x/x \in \mathbf{N}, x^2 - 6x + 5 = 0\}$, $A' =$ _____
- (a) $\{1, 5\}$
 - (b) $(1, 5)$
 - (c) $[1, 5]$
 - (d) $[-1, -5]$
- Q10. If A and B are two sets such that $n(A) = 115, n(B) = 326, n(A - B) = 47$, then write $n(A \cup B) =$
- (a) 372
 - (b) 373
 - (c) 400
 - (d) none of these



Answer & Solution

ANSWER

Q1	Q2	Q3	Q4	Q5
(b)	(b), (c), (d)	(b), (c), (d)	(a)	(b)
Q6	Q7	Q8	Q9	Q10
(c)	(c)	(b)	(b)	(b)

miso
study

JEE Advanced Pattern Exercise (1)

Q1. Two finite sets have m and n element respectively. The total number of subsets of first set is 112 more than the total number of subsets of the second set. The value of m and n respectively are:

- (a) 5.2
- (b) 4.7
- (c) 7.4
- (d) 2.5

Q2. A survey shows that 70% of the Indians like mango wheres 82% like apple. If $x\%$ of Indian like both mango and apples then:

- (a) $x = 52$
- (b) $52 \leq x \leq 70$
- (c) $x = 70$
- (d) $70 \leq x \leq 82$

Q3. If $X \cup \{3, 4\} = \{1, 2, 3, 4, 5, 6\}$ the which of the following is true

- (a) Smallest set $X = \{1, 2, 5, 6\}$
- (b) Smallest set $X = \{1, 2, 3, 5, 6\}$
- (c) Smallest set $X = \{1, 2, 3, 4\}$
- (d) Greatest set $X = \{1, 2, 3, 4\}$

Q4. In a certain town 30% families own a scooter and 40% on a car 50% own neither a scooter nor a car 2000 families own both a scooter and car consider the following statements in this regard

- (1) 20% families own both scooter and car
- (2) 35% families own either a car or a scooter
- (3) 10000 families live in town.

Which of the above statement are correct ?

- (a) 2 and 3
- (b) 1, 2 and 3
- (c) 1 and 2
- (d) 1 and 3

Q5. Let $A = \{\theta : \tan \theta + \sec \theta = \sqrt{2} \sec \theta\}$ and $B = \{\theta : \sec \theta - \tan \theta = \sqrt{2} \tan \theta\}$ be two sets then.

- (a) $A = B$
- (b) $A \subset B$
- (c) $A \neq B$
- (d) $B \subset A$

Q6. A and B are two sets $n(A-B)=8+2x$, $n(B-A)=6x$ and $n(A \cap B)=x$. If $n(A)=n(B)$ then $n(A \cap B)=$ _____

- (a) 26 (c) 24
(b) 50 (d) none of these

Q7. $A = \{(a,b)/b=2a-5\}$ If $(m,5)$ and $(6,n)$ are the member of set A then m and n are respectively

- (a) 5,7 (c) 2,3
(b) 7,5 (d) 5,3

Q8. There are three-three sets given in column- A and column- B

Column-A	Column-B
(1) $\{L, A, T\}$	(A) $\{x/x \in z, x^2 < 5\}$
(2) $\{x \in z / x^3 - x = 0\}$	(B) $\{x/x \text{ is a letter of the word LATA}\}$
(3) $\{-2, -1, 0, 1, 2\}$	(C) $\left\{\sin 0, \sin \frac{3\pi}{2}, \tan \frac{5\pi}{4}\right\}$

Which one of the following matches is correct?

- (a) 1-A, 2-B, 3-C (c) 1-B, 2-C, 3-A
(b) 1-B, 2-A, 3-C (d) 1-A, 2-C, 3-B

Q9. If $A = \{n^3 + (n+1)^3 + (n+z)^3; n \in \mathcal{N}\}$ and $B = \{9n, n \in \mathcal{N}\}$ then

- (a) $A \subset B$ (c) $A = B$
(b) $B \subset A$ (d) $A' = B$

Q10. If A and B be two sets containing 3 and 6 elements respectively, what can be the minimum number of elements in $A \cup B$? Find also, the maximum number of elements in $A \cup B$.

- (a) 9, 6
(b) 8, 5
(c) 7, 4
(d) 6, 3



Answer & Solution

ANSWER

Q1	Q2	Q3	Q4	Q5
(c)	(b)	(a)	(d)	(a)
Q6	Q7	Q8	Q9	Q10
(d)	(a)	(c)	(a)	(a)

miso
study

JEE PHYSICS

- ▶ Specially designed eBook for complete JEE syllabus
- ▶ JEE preparation strategy & direction, speedy revision
- ▶ Chapter-wise important Problem-Solving
- ▶ Theory, Formulas & Diagrams to crack JEE
- ▶ Detailed high quality video lectures by experienced faculties
- ▶ JEE full preparation for Class XI & XII



misostudy
connect smart learning

JEE·NEET·AIIMS·CBSE·FOUNDATION
www.misostudy.com

☎ 8929803804 (MON-FRI: 9am-6pm) support@misostudy.com

MISO STUDY INDIA PVT. LTD.
2ND FLOOR 65-A, OMPRO TOWER, KALU SARAI, NEW DELHI, DELHI 110016

Class 12 | Physics

01 Electrostatics-I

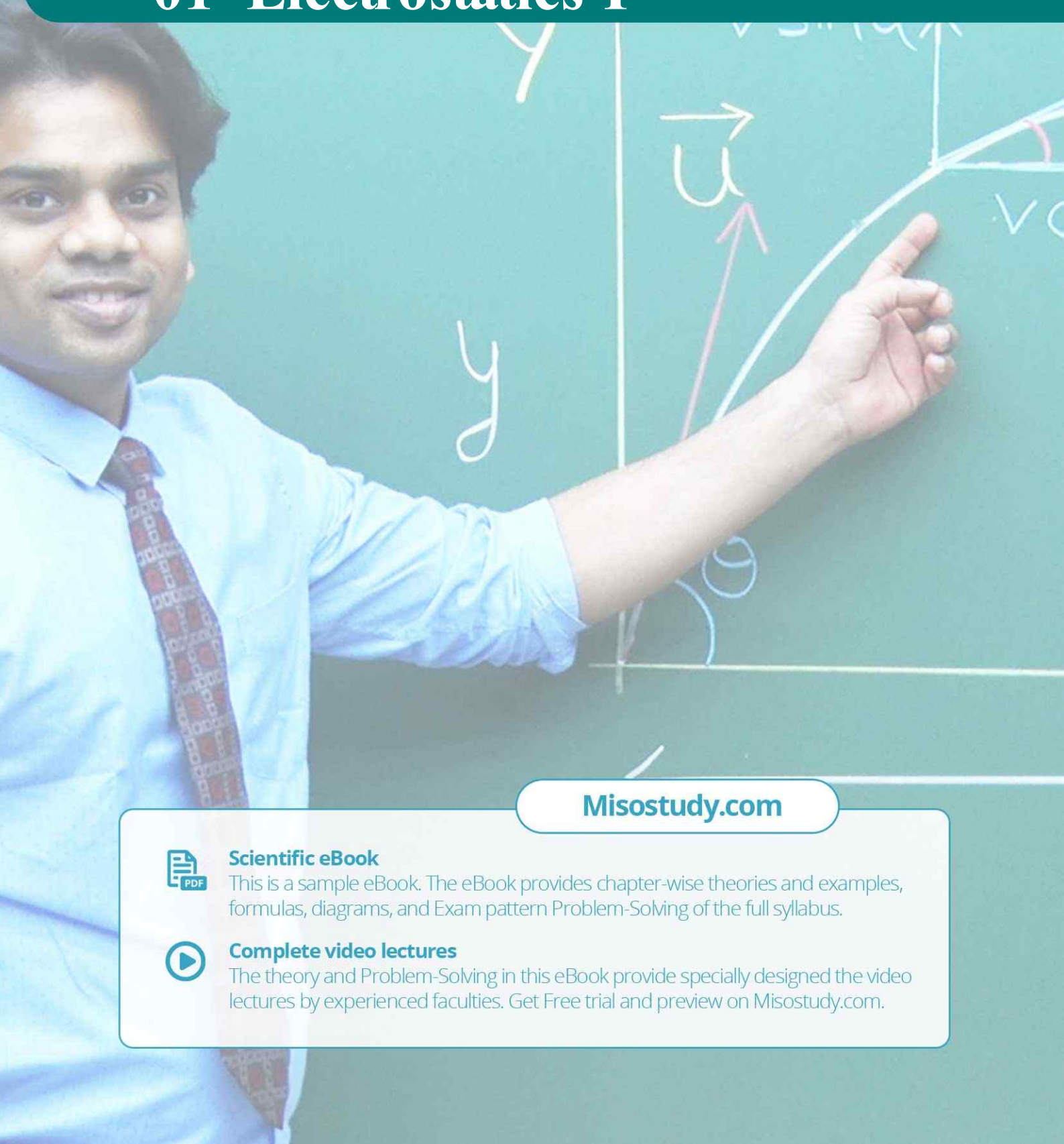

Misostudy.com



Scientific eBook

This is a sample eBook. The eBook provides chapter-wise theories and examples, formulas, diagrams, and Exam pattern Problem-Solving of the full syllabus.



Complete video lectures

The theory and Problem-Solving in this eBook provide specially designed the video lectures by experienced faculties. Get Free trial and preview on Misostudy.com.

01 Electrostatics-I

01. Introduction

Electrostatics, deals with the study of charges in rest. These stationary charges occurs due to friction of two insulating bodies, therefore it is often called frictional electricity.

Important points

- (i) Gravitational force is the weakest while nuclear force is the strongest force of the nature
- (ii) Nuclear force does not depend upon charge, it acts equally between proton-proton, proton neutron and neutron-neutron.
- (iii) There are weak forces acting in β -degradation in radio-activity.
- (iv) A stationary charge produces electric field while a moving charge produce electric as well as magnetic field.
- (v) Moving charge produce electric field as well as magnetic field but does not radiate energy while uniform acceleration.
- (vi) Accelerated charge produce electric field as well as magnetic field and radiate energy.

02. Charge

Property of a substance by virtue of which it can repel or attract another charged substance.

Charges are of two types

(a) **Positive charge** : Lesser number of electrons than number of protons.

(b) **Negative charge** : More number of electrons than number of protons

Important Points : Only, electron is responsible for a substance to be charged and not the proton.

Properties of Charge

- (i) Like charges repel while unlike charges attract each other.
- (ii) Charge is quantized in nature i.e. The magnitude of charge possessed by different objects is always and integral multiple of charge of electron (or proton) i.e. $q = \pm ne$ where $n = 1, 2, 3, \dots$
- (iii) The minimum possible charge that can exist in nature is the charge of electron which has a magnitude of $e = 1.60207 \times 10^{-19}$ coulomb. This is also known as quantum of charge or fundamental charge.
- (iv) In an isolated system the algebraic sum of total charge remains constant. This is the law of 'Conservation of charge'.

03. Coulomb's Law

The force of attraction or repulsion between two stationary point charges is directly proportional to the product of charges and inversely proportional to the square of distance between them. This force acts along the line joining the two. If q_1 & q_2 are charges in consideration r , the distance between them and F , the force acting between them

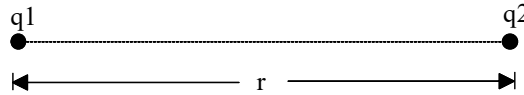

Then, $F \propto q_1 q_2$

$$F \propto 1/r^2$$

$$\therefore F \propto \frac{q_1 q_2}{r^2}$$

$$\Rightarrow F = K \frac{q_1 q_2}{r^2}, \text{ where } k = \text{constant.}$$

$$K = \frac{1}{4\pi\epsilon_0\epsilon_r} = \frac{9 \times 10^9}{\epsilon_r} \text{ Nm}^2\text{C}^{-2}$$

where,

ϵ_0 = Electric permittivity of vacuum or air

$$= 8.85 \times 10^{-12} \text{ C}^2\text{N}^{-1}\text{m}^{-2} \text{ and}$$

K or ϵ_r = Relative permittivity or Dielectric constant or Specific inductive capacity

$$\epsilon_r = \frac{\epsilon}{\epsilon_0} \Rightarrow \epsilon = \epsilon_0\epsilon_r$$

[Newton's law for particles is analogous to coulomb's law for rest charge. The difference is that Newton's law gives attraction force while coulomb's law gives attraction as well as repulsion force]

- NOTE** (i) Coulomb's law is applicable to point charges only. But it can be applied for distributed charges also
- (ii) This law is valid only for stationary charges and cannot be applied for moving charges.
- (iii) This law is valid only if the distance between two charges is not less than 10^{-15} m

Direction

Direction of the force acting between two charges depends upon their nature and it is along the line joining two charges.

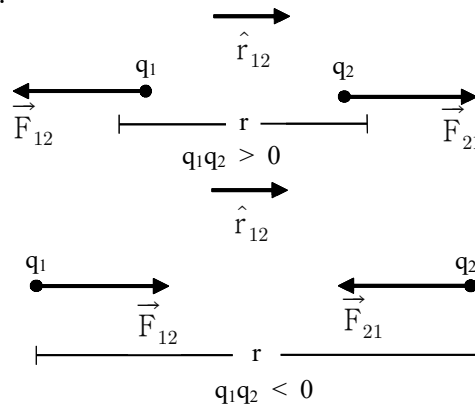

\vec{F}_{21} = force on q_2 due to q_1

$$\vec{F}_{21} = \frac{q_1 q_2}{4\pi\epsilon_0\epsilon_r r_{12}^2} \hat{r}_{12} \quad \dots\dots(A)$$

(where \hat{r}_{12} is a unit vector pointing from q_1 to q_2)

\vec{F}_{12} = Force on q_1 due to q_2

$$\vec{F}_{12} = \frac{q_1 q_2}{4\pi\epsilon_0\epsilon_r r_{12}^2} \hat{r}_{21} \quad \dots\dots(B)$$

(where \hat{r}_{21} is a unit vector pointing from q_2 to q_1)

⇒ Electric force between two charges not depends on neighbouring charges.

⇒ If a dielectric slab (ϵ_r) of thickness 't' is placed between two charges (distance d), force decreases.

$$F = \frac{Q_1 Q_2}{4\pi\epsilon_0 r^2} \quad \text{where } r = d - t + t\sqrt{\epsilon_r}$$

04. Electric Field

A charge produces something called an electric field in the space around it and this electric field exerts a force on any charge placed in it.

NOTE The electric field does not exert force on source charge.

Electric field Intensity

Force experienced by a unit positive charge placed in an electric field at a point is called electric field intensity at that point. It is also known as electric field simply. Let q_0 be the positive test charge placed in an electric field. If \vec{F} is the force experienced by this charge, then

$$\vec{E} = \lim_{q_0 \rightarrow 0} \frac{\vec{F}}{q_0}$$

- (i) Unit : N/C or volt/metre
- (ii) This is a vector quantity and its direction is the same as force on the positive test charge.

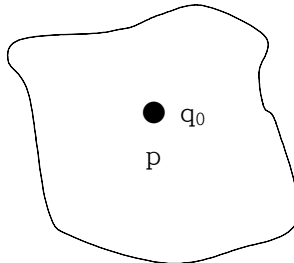

- (iii) Since \vec{E} is the force on unit charge, force on charge q is. $\vec{F} = q\vec{E}$.

- (iv) Dimension is $[M^1L^1T^{-3}A^{-1}]$
 (v) Electric field due to a point charge is

$$\vec{E} = \frac{kq}{r^2} \cdot \hat{r}$$

- (vi) Direction of electric field due to positive charge is away from charge while direction of electric field due to negative charge is towards the charge.

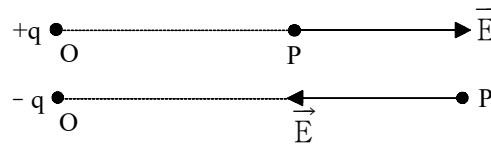

Special point

- (a) If q_1 and q_2 are at a distance r and both have the same type of charge, then the distance 'd' of the point from q_1 where electric field is zero is given by $d = \frac{\sqrt{q_1} r}{(\sqrt{q_1} + \sqrt{q_2})}$. This point will lie between line joining q_1 & q_2 .

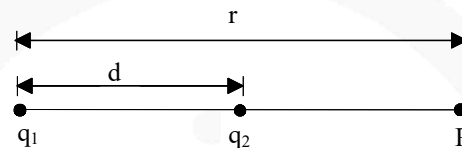

- (b) If q_1 and q_2 have opposite charges then distance 'd' of the point 'p' from q_1 where electric field is zero is given by

$$d = \frac{\sqrt{q_1} r}{\sqrt{q_1} - \sqrt{q_2}}, \quad [|q_1| > |q_2|]$$

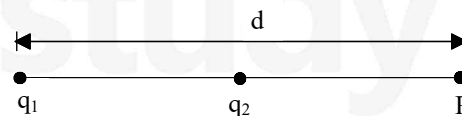

- (c) Three charges $+Q_1$, $+Q_2$ and q are placed on a straight line. If this system of charges is in equilibrium, charge q should be a given

$$q = \frac{Q_1 Q_2}{(\sqrt{Q_1} + \sqrt{Q_2})^2}$$

⇒ For measuring \vec{E} practically a test charge (+ve) of magnitude much less than the source charge should be used.

⇒ Electric force on a charge in uniform E is constant and hence acceleration is constant, so equations of motion can be used

$$\text{(acceleration } a = \frac{qE}{m})$$

⇒ Electric field due to linear charge distribution (a) Finite wire

(d) Finite wire

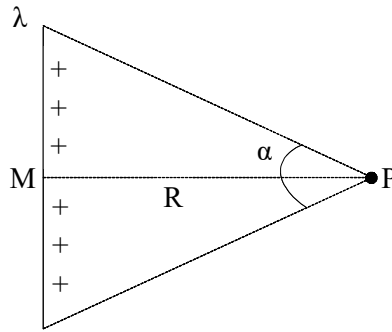

$$E_p = \frac{2k\lambda}{R} \sin \frac{\alpha}{2}$$

(e) Infinite wire ($\alpha = 180^\circ$)

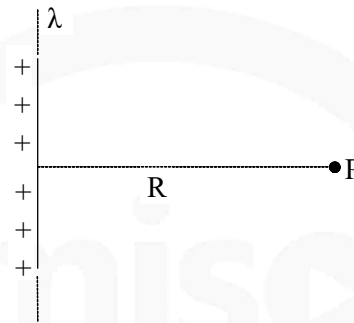

$$E_p = \frac{2k\lambda}{R}$$

(f) Charged arc

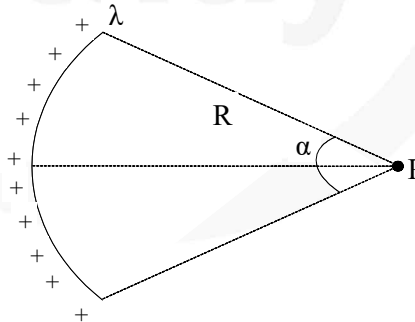

$$E_p = \frac{2k\lambda}{R} \sin \left(\frac{\alpha}{2} \right)$$

(g) Charged ring of radius R

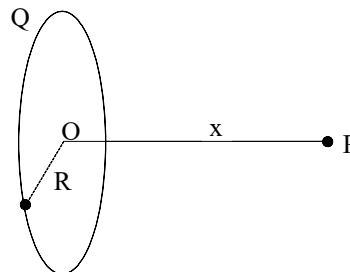

at and axial point $E_p = \frac{kQx}{(R^2+x^2)^{3/2}}$;

$$x \gg R \Rightarrow E_p = \frac{kQ}{x^2}$$

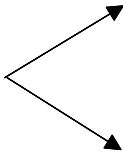
If 

$$x \ll R \Rightarrow E_p = \frac{kqx}{R^2}$$

As x is increases: \vec{E} due to ring first \uparrow then \downarrow and at $X = \frac{R}{\sqrt{2}}$ it is maximum.

Electric lines of forces : (ELF)

The electric field in a region can be represented by drawing certain curves known as electric lines of force.

An electric line of force is that imaginary smooth curve drawn in an electric field along which a free isolated unit positive charge moves.

Properties

- (i) Imaginary
- (ii) Can never cross each other
- (iii) Can never be closed loops
- (iv) The number of lines originating or terminating on a charge is proportional to the magnitude of charge. In rationalised MKS $\left(\frac{1}{\epsilon_0}\right)$ system electric lines are associated with unit charge, so if a body encloses q , total lines of force associated with it (called flux) will be q/ϵ_0 .
- (v) Total lines of force may be fractional as lines of force are imaginary.

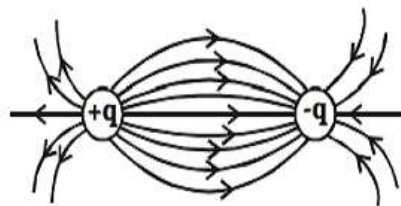

- (vi) Lines of force ends or starts normally at the surface of a conductor.
- (vii) If there is no electric field there will be no lines of force.
- (viii) Lines of force per unit area normal to the area at a point represents magnitude of intensity, crowded lines represent strong field while distant weak field.
- (ix) Tangent to the line of force at a point in an electric field gives the direction of intensity. So a positive charge free to move follow the line of force.

05. Electric Dipole

- (i) An system consisting of two equal and opposite charges separated by a small distance is termed and electric dipole.

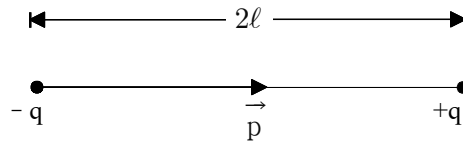

Example : Na^+Cl^- , H^+Cl^- etc.

- (ii) An isolated atom is not a dipole because centre of positive charge coincides with centre of negative centres. But if atom is placed in an electric field, then the positive and negative centres are displaced relative to each other and atom become a dipole.
- (iii) **DIPOLE MOMENT:** The product of the magnitude of charges and distance between them is called the dipole moment.

It is denoted by \vec{p} and $|\vec{p}| = q \times 2\ell$

- (a) This is a vector quantity which is directed from negative to positive charge.
 (b) Unit : C-m
 (c) Dimension : $[\text{M}^0\text{L}^1\text{T}^1\text{A}^1]$

Electric field due to a dipole

- (i) There are two components of electric field at any point
- (a) $E_r \rightarrow$ in the direction of \vec{r}
 (b) $E_\theta \rightarrow$ in the direction perpendicular to \vec{r}

$$E_r = \frac{1}{4\pi\epsilon_0} \cdot \frac{2p \cos \theta}{r^3}$$

$$E_\theta = \frac{1}{4\pi\epsilon_0} \cdot \left(\frac{p \sin \theta}{r^3} \right)$$

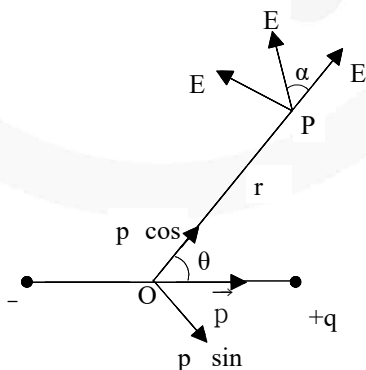

- (i) Resultant

$$E = \sqrt{E_r^2 + E_\theta^2} = \frac{p}{4\pi\epsilon_0 r^3} \sqrt{1 + 3\cos^2 \theta}$$

- (ii) Angle between the resultant \vec{E} and \vec{r} , α given

$$\text{by } \alpha = \tan^{-1} \left(\frac{E_\theta}{E_r} \right) = \tan^{-1} \left(\frac{1}{2} \tan \theta \right)$$

(iii) If $\theta = 0$, i.e. point is on the axis -

$$E_{\text{axis}} = \frac{2kp}{r^3} \quad (r \gg \ell)$$

(iv) If $\theta = 90^\circ$, i.e. point is on the line bisecting the dipole perpendicularly

$$E_{\text{equatorial}} = \frac{kp}{r^3} \quad (r \gg \ell)$$

(v) So, $E_{\text{axis}} = 2E_{\text{equatorial}}$ (for same r)

$$(vi) \quad E_{\text{axis}} = \frac{1}{4\pi\epsilon_0} \cdot \frac{2pr}{(r^2 - \ell^2)^2}$$

$$E_{\text{equatorial}} = \frac{1}{4\pi\epsilon_0} \cdot \frac{p}{(r^2 + \ell^2)^{3/2}}$$

where $p = q \cdot (2\ell)$

(vii)

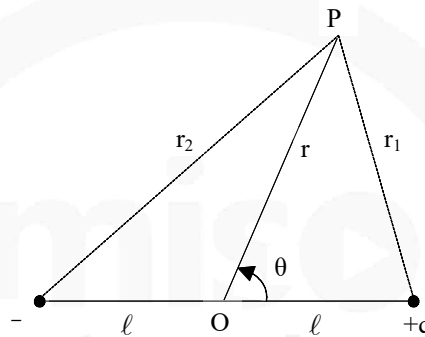

potential at a general point.

$$V = \frac{1}{4\pi\epsilon_0} \frac{p \cos \theta}{r^2}$$

(viii) If $\theta = 0^\circ$, $V_{\text{axis}} = \frac{kp}{r^2}$

(ix) If $\theta = 90^\circ$, $V_{\text{equator}} = 0$

(x) Here we see that $V = 0$ but $E \neq 0$ for points at equatorial position.

(xi) Again, if $r \gg d$ is not true and $d = 2\ell$,

$$V_{\text{axis}} = \frac{1}{4\pi\epsilon_0} \cdot \frac{p}{(r^2 - \ell^2)}$$

$$V_{\text{equator}} = 0$$

- NOTE**
- (i) This is not essential that at a point, where $E = 0$, V will also be zero there eg. inside a uniformly charged sphere, $E = 0$ but $V \neq 0$
 - (ii) Also if $V = 0$, it is not essential for E to be zero eg. in equatorial position of dipole $V = 0$, but $E \neq 0$

Electric Dipole In an Electric Field – Uniform Electric Field

(i) When an electric dipole is placed in a uniform electric field, A torque acts on it which subjects the dipole to rotatory motion. This τ is given by $\tau = pE \sin\theta$ or $\vec{\tau} = \vec{p} \times \vec{E}$

(ii) Potential energy of the dipole

$$U = -pE \cos\theta = -\vec{p} \cdot \vec{E}$$

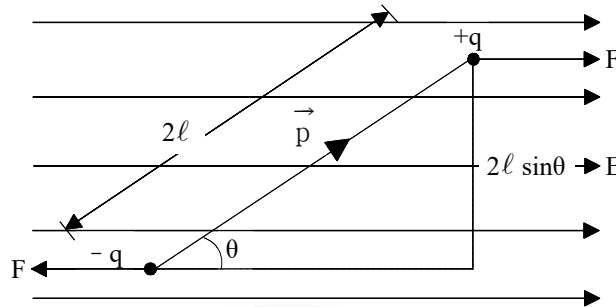

Cases

- If $\theta = 0^\circ$, i.e. $\vec{p} \parallel \vec{E}$, $\tau = 0$ and $U = -pE$, dipole is in the minimum potential energy state and no torque acting on it and hence it is in the stable equilibrium state.
- For $\theta = 180^\circ$, i.e. \vec{p} and \vec{E} are in opposite direction, then $\tau = 0$ but $U = pE$ which is maximum potential energy state. Although it is in equilibrium but it is not a stable state and a slight perturbation can disturb it.
- $\theta = 90^\circ$, i.e. $\vec{p} \perp \vec{E}$, then $\tau = pE$ (maximum) and $U = 0$

Work done in rotating an electric dipole in and electric field

- To rotate the dipole by an angle θ from the state of stable equilibrium $W = pE(1 - \cos\theta)$.
- Work done in rotating the dipole from θ_1 to θ_2 in an uniform electric field $W = pE(\cos\theta_1 - \cos\theta_2)$
- Work done in rotating the dipole through 180° from stable equilibrium state $W = 2pE = 2$ (potential energy)

06. Electric Flux

- It is denoted by ' ϕ '.
- It is a scalar quantity.
- It is defined as the total number of lines of force passing normally through a curved surface placed in the field.
- It is given by the dot product of \vec{E} and normal infinitesimal \vec{ds} area integrated over a closed surface.

$$d\phi = \vec{E} \cdot \vec{ds}$$

$$\phi = \oint \vec{E} \cdot \vec{ds} = \oint E ds \cos\theta$$

where θ = angle between electric field and normal to the area

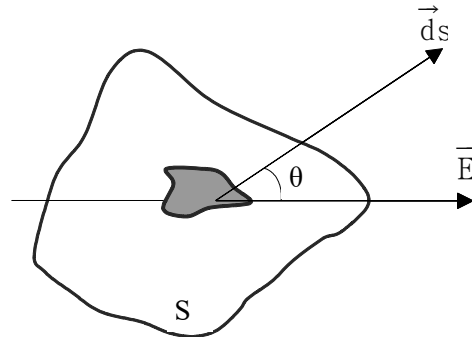

- (v) Unit : (a) $\text{N}\cdot\text{m}^2/\text{C}$ (b) volt – meter
- (vi) Dimension : $[\text{ML}^3\text{T}^{-3}\text{A}^{-1}]$
- (vii) Flux due to a positive charge goes out of the surface while that due to negative charge comes into the surface.
- (viii) Value of electric flux is independent of shape and size of the surface.
- (ix) If only a dipole is present in the surface then net flux is zero.
- (x) Net flux from a surface is zero does not imply that intensity of electric field is also zero.

07. Gauss's Law

This law states that electric flux ϕ_E through any closed surface is equal to $1/\epsilon_0$ times the net charge 'q' enclosed by the surface i.e

$$\phi_E = \oint \vec{E} \cdot \vec{ds} = \frac{q}{\epsilon_0}$$

Important point about flux

- Independent of distances between charges inside the surface and their distribution.
- Independent of shape, size and nature of surface.
- Net flux due to a charge outside the surface will be zero.
- Gauss law is valid only for the vector fields which obey inverse square law

Example

A hemispherical surface of radius R is kept in a uniform electric field E such that E is parallel to the axis of hemi-sphere, Net flux from the surface will be

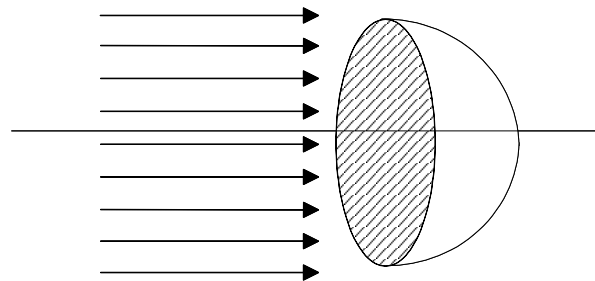

Solution

$$\begin{aligned} \phi &= \oint \vec{E} \cdot \vec{ds} = E \cdot \pi R^2 \\ &= (E) (\text{Area of surface perpendicular to } E) \\ &= E \cdot \pi R^2. \end{aligned}$$

08. Application of Gauss's Law

Electric field due to a solid conducting sphere/Hollow conducting sphere.

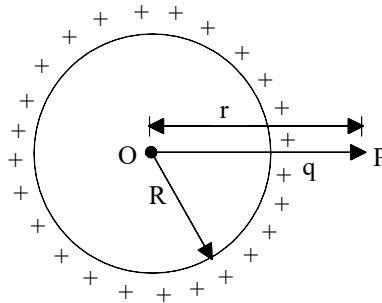

(i) **Case: 1** $r > R$ $\vec{E} = \frac{kq}{r^2} \hat{r} = \frac{1}{\epsilon_0} \frac{\sigma R^2}{r^2} \hat{r}$

Case: 2 $r = R$ $\vec{E} = \frac{\sigma}{\epsilon_0} \hat{r}$

Case: 3 $r < R$ $\vec{E} = 0$

i.e. At point interior to a conducting or a hollow sphere, electric field intensity is zero.

- (ii) For points outside the sphere, it behaves like all the charge is present at the centre.
(iii) Intensity of electric field is maximum at the surface

Imp.

- (iv) Electric field at the surface is always perpendicular to the surface.
(v) For points, near the surface of the conductor, $E = \frac{\sigma}{\epsilon_0}$ perpendicular to the surface

Electric field due to infinitely long charge

- (i) A long wire is given a line charge density λ . If wire is positively charged, direction of \vec{E} will be away from the wire (outward \perp) while for a negatively charged wire, direction of \vec{E} will be (inward \perp) towards the wire.
(ii) E at point p

$$\vec{E} = \frac{\lambda}{2\pi\epsilon_0 r} \hat{r} \quad \text{or} \quad E = \frac{\lambda}{2\pi\epsilon_0 r}$$

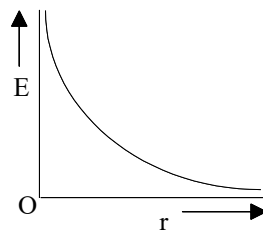

- (iii) Potential difference between points A (r_1) & B (r_2) = $V_2 - V_B = \frac{\lambda}{2\pi\epsilon_0} \ln \left(\frac{r_2}{r_1} \right)$
(iv) Potential difference between points A (r_1) & B (r_2) = $V_2 - V_B = \frac{\lambda}{2\pi\epsilon_0} \ln \left(\frac{r_2}{r_1} \right)$

Electric field at a point due to an infinite sheet of charge

- (i) If σ = surface charge density. Intensity at points near to the sheet $\vec{E} = \frac{\sigma}{2\epsilon_0} \hat{r}$

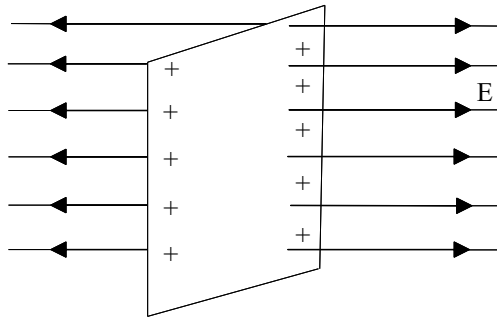

- (ii) Direction of electric field is perpendicular to the sheet of charge.
 (iii) Intensity of electric field does not depend upon the distance of points from the sheet for the points in front of sheet i.e. There is an equipotential region near the charged sheet.
 (iv) Potential difference between two points A & B at distances r_1 & r_2 respectively is

$$V_A - V_B = \frac{\sigma}{2\epsilon_0} (r_2 - r_1)$$

Electric field due to infinite charged metal plate

- (i) Intensity at points near the plate $\vec{E} = \frac{\sigma}{\epsilon_0} \hat{r}$

where σ = surface charge density

- (ii) \vec{E} is independent of distance of the point from the plate and also of the area of sheet i.e. There is an equipotential region near the plate.

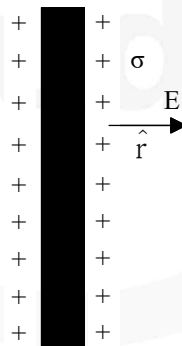

- (iii) Direction of electric field is perpendicular to the plate.
 (iv) Potential difference between two point A (r_1) and B (r_2) ($r_1 < r_2$) near the plate is

$$\Delta V = V_A - V_B = \frac{\sigma}{\epsilon_0} (r_2 - r_1)$$

Electric field due to charged ring : Q charge is distributed over a ring of radius R.

- (i) Intensity of electric field at a distance x from the centre of ring along it's axis-

$$E = \frac{1}{4\pi\epsilon_0} \frac{Q \cos\theta}{r^2} = \frac{Qx}{4\pi\epsilon_0 r^3} \quad (\because \cos\theta = x/r)$$

$$= \frac{1}{4\pi\epsilon_0} \frac{Qx}{(R^2 + x^2)^{3/2}} \quad [\because r = \sqrt{R^2 + x^2}]$$

and it's direction will be along the axis of the ring.

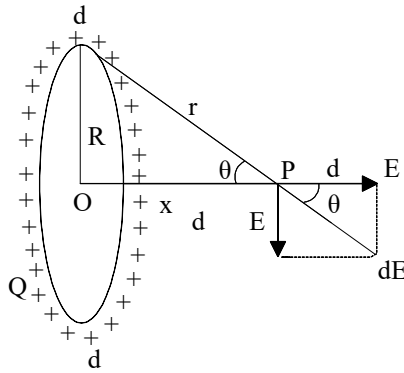

- (ii) Intensity will be zero at the centre of the ring.
 (iii) Intensity will be maximum at a distance $R/\sqrt{2}$ from the centre and

$$E_{\max} = \frac{2}{3\sqrt{3}} \cdot \frac{1}{4\pi\epsilon_0} \cdot \frac{Q}{R^2}$$

- (iv) Electric potential at a distance x from centre,

$$V = \frac{1}{4\pi\epsilon_0} \frac{Q}{\sqrt{(x^2 + R^2)}}$$

miso
study

JEE Main Pattern Exercise (1)

- A particle of charges Q and mass m travels through a potential difference V from rest. The final momentum of the particle is

(a) $\frac{mv}{Q}$	(c) $\sqrt{2mQV}$
(b) $2Q\sqrt{mV}$	(d) $\sqrt{\frac{2QV}{m}}$
- Three concentric conducting spherical shells carry charges as follows $+4Q$ on the inner shell, $-2Q$ on the middle shell and $-5Q$ on the outer shell. The charge on the inner surface of the outer shell is

(a) 0	(c) $-Q$
(b) $4Q$	(d) $-2Q$
- The work done against electric forces in increasing the potential difference of a condenser from 20V to 40V is W . The work done in increasing its potential difference from 40V to 50 V will be

(a) $4W$	(c) $2W$
(b) $\frac{3W}{4}$	(d) $\frac{W}{2}$
- The plate separation in a parallel plate condenser is d and plate area is A . If it is charged to V volt and battery is disconnected then the work done in increasing the plate separation to $2d$ will be

(a) $\frac{3}{2} \frac{\epsilon_0 A V^2}{d}$	(c) $\frac{2\epsilon_0 A V^2}{d}$
(b) $\frac{\epsilon_0 A V^2}{d}$	(d) $\frac{\epsilon_0 A V^2}{2d}$
- A parallel plate condenser is connected to a battery of e.m.f. 4 volt. If a plate of dielectric constant 8 is inserted into it, then the potential difference on the condenser will be

(a) 0.5V	(c) 4V
(b) 2V	(d) 32V

01 Electrostatics-I

6. A solid sphere of radius R is charged uniformly. At what distance from its surface is the electrostatic potential half of the potential at the centre?
- (a) R (c) $R/3$
(b) $R/2$ (d) $2R$
7. A particle of charge $1 \mu\text{C}$ and mass 1 gm moving with a velocity of 4 m/s is subjected to a uniform electric field of magnitude 300 V/m for 10s . Its final speed cannot be
- (a) 0.5 m/s (c) 3 m/s
(b) 4 m/s (d) 6 m/s
8. Electric field on the axis of a small electric dipole at a distance r is \vec{E}_1 and \vec{E}_2 at a distance of $2r$ on a line of perpendicular bisector. Then
- (a) $\vec{E}_2 = -\vec{E}_{1/8}$ (c) $\vec{E}_2 = -\vec{E}_{1/4}$
(b) $\vec{E}_2 = -\vec{E}_{1/16}$ (d) $\vec{E}_2 = \vec{E}_{1/8}$
9. An electric field is given by $\vec{E} = (y\hat{i} + x\hat{j})\text{N/C}$. The work done in moving a 1C charge from $\vec{r}_A = (2\hat{i} + 2\hat{j})\text{m}$ to $\vec{r}_B = (4\hat{i} + \hat{j})\text{m}$ is
- (a) $+ 4 \text{ J}$ (c) $+ 8 \text{ J}$
(b) $- 4 \text{ J}$ (d) zero
10. A hollow metal sphere of radius 5 cm is charged such that the potential on its surface is 10 V . The potential at the centre of the sphere is
- (a) zero
(b) 10 V
(c) same as at a point 5 cm away from the surface
(d) same as at a point 25 cm away from the surface

JEE Advanced Pattern Exercise (1)

(Q1 & 2) Only One Correct Option

- The potential field of an electric field $\vec{E} = (y\hat{i} + x\hat{j})$ is
 - $V = -xy + \text{constant}$
 - $V = -(x + y) + \text{constant}$
 - $V = -(x^2 + y^2) + \text{constant}$
 - $V = \text{constant}$
- Capacity of an isolated sphere is increased n times when it is enclosed by an earthed concentric sphere. The ratio of their radii is

<ol style="list-style-type: none"> $\frac{n^2}{n-1}$ $\frac{n}{n-1}$ 	<ol style="list-style-type: none"> $\frac{2n}{n+1}$ $\frac{2n+1}{n+1}$
--	--

(Q3) More than One Correct Option

- Figure shows some of the electric field lines corresponding to an electric field. The figure suggests that ($E =$ electric field, $V =$ potential)

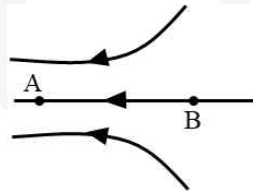

- | | |
|--|--|
| <ol style="list-style-type: none"> $E_A > E_B$ $E_A < E_B$ | <ol style="list-style-type: none"> $V_A > V_B$ $V_A < V_B$ |
|--|--|

(Q4 to 5) Comprehension Type

Passage

A charge $q = (-2 \times 10^{-9})$ C is placed at $(1\text{m}, 2\text{m}, 3\text{m})$. There is a point $P = (2\text{m}, -3\text{m}, 4\text{m})$

- A unit vector in the direction of electric field at P due to charge q will be

- | | |
|---|---|
| <ol style="list-style-type: none"> $\frac{1}{3\sqrt{3}}(\hat{i} - 5\hat{j} + \hat{k})$ $\frac{1}{3\sqrt{3}}(-\hat{i} + 5\hat{j} - \hat{k})$ | <ol style="list-style-type: none"> $\frac{1}{5\sqrt{2}}(3\hat{i} + 4\hat{j} - 5\hat{k})$ $\frac{1}{5\sqrt{2}}(-3\hat{i} + 4\hat{j} - 5\hat{k})$ |
|---|---|

5. Component of electric field along x -axis at point P would be

- (a) $\frac{1}{5\sqrt{3}}$ N/C (c) $\frac{2}{9\sqrt{3}}$ N/C
 (b) $\frac{9}{5\sqrt{3}}$ N/C (d) $8\sqrt{3}$ N/C

(Q6 & 7) Only One Correct Option

6. A spherical charged conductor has surface charge density σ . The electric field on its surface is E and electric potential of conductor is V . Now the radius of the sphere is halved keeping the charge to be constant. The new values of electric field and potential would be

- (a) $2E, 2V$ (c) $4E, 4V$
 (b) $4E, 2V$ (d) $2E, 4V$

7. Two concentric spherical conducting shells of radii R and $2R$ carry charges Q and $2Q$ respectively. Change in electric potential on the outer shell when both are connected by a conducting wire is $\left(k = \frac{1}{4\pi\epsilon_0}\right)$

- (a) zero (c) $\frac{kQ}{R}$
 (b) $\frac{3kQ}{2R}$ (d) $\frac{2kQ}{R}$

(Q8) More than One Correct Option

8. A circular ring carries a uniformly distributed positive charge. The electric field (E) and potential (V) varies with distance (r) from the centre of the ring along its axis as

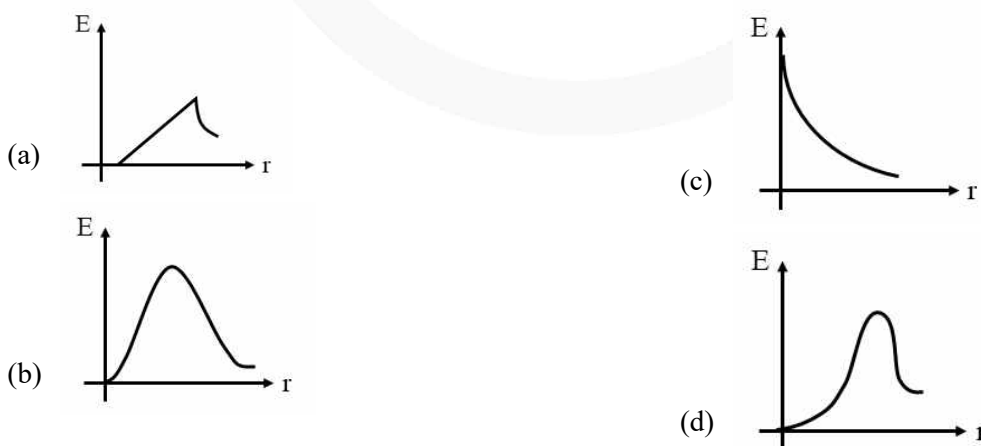

(Q9) Matrix Match Type

9. In the figure shown, P is a point on the surface of an imaginary sphere. Match the following.

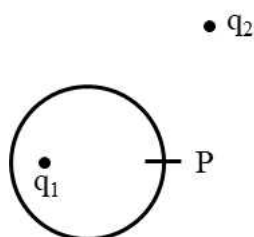

Table-1	Table-2
(a) Electric field at point P	(p) due to q_1 only
(b) Electric flux through a small area at P	(q) due to q_2 only
(c) Net electric flux through whole sphere	(r) due to both q_1 and q_2

(Q10) Integer Type

10. The centers of two identical small conducting spheres are 1 m apart. They carry charges of opposite kind and attract each other with a force F . When they are connected by conducting thin wire they repel each other with a force $F/3$. The ratio of magnitude of charges carried by the spheres initially is $n : 1$. Find value of n .

JEE

CHEMISTRY

- ▶ Specially designed eBook for complete JEE syllabus
- ▶ JEE preparation strategy & direction, speedy revision
- ▶ Chapter-wise important Problem-Solving
- ▶ Theory, Formulas & Diagrams to crack JEE
- ▶ Detailed high quality video lectures by experienced faculties
- ▶ JEE full preparation for Class XI & XII



misostudy
connect smart learning

JEE·NEET·AIIMS·CBSE·FOUNDATION
www.misostudy.com

☎ 8929803804 (MON-FRI: 9am-6pm) support@misostudy.com

MISO STUDY INDIA PVT. LTD.
2ND FLOOR 65-A, OMPRO TOWER, KALU SARAI, NEW DELHI, DELHI 110016

Class 12 | Chemistry

02 Solid State

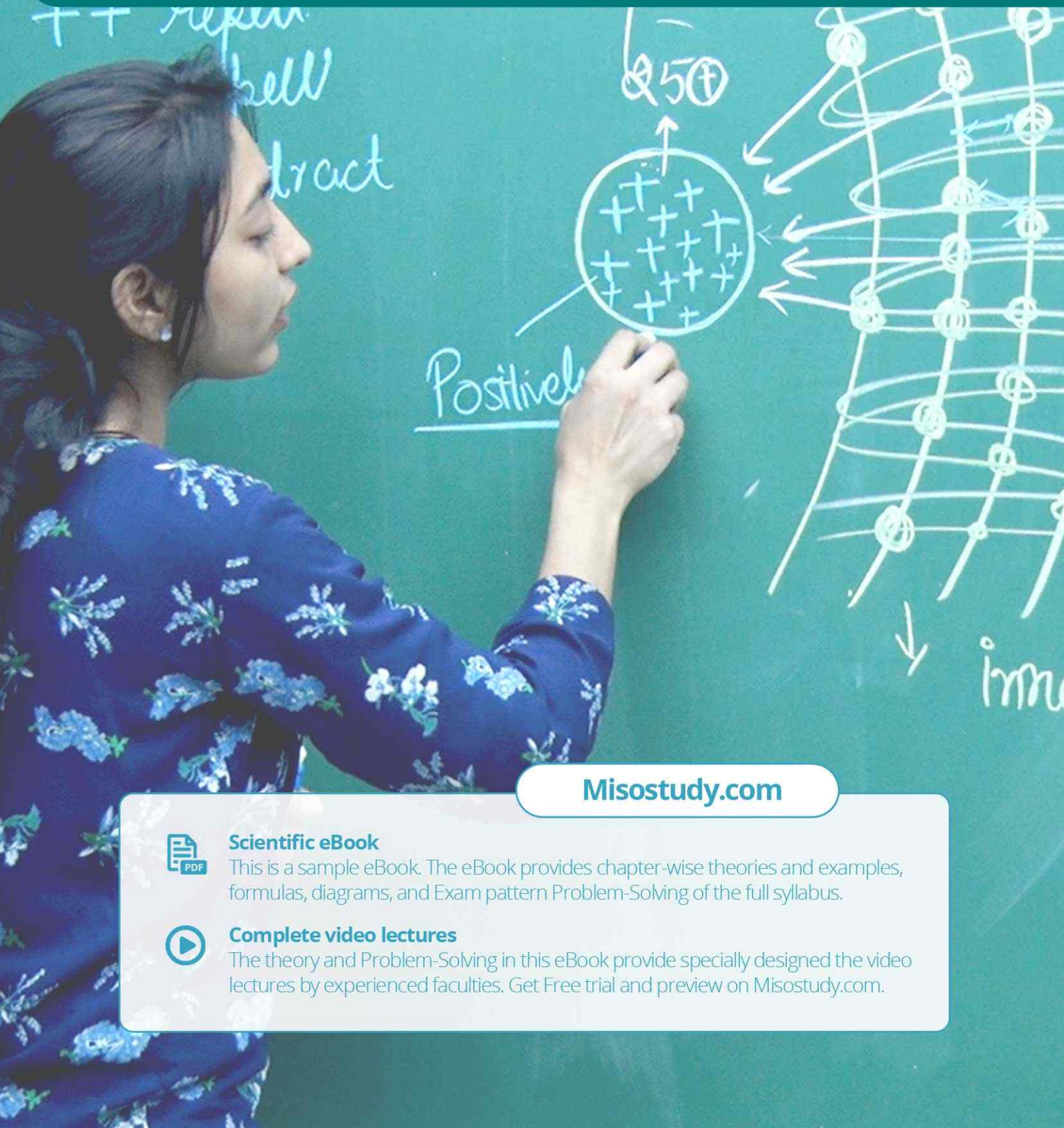

Misostudy.com



Scientific eBook

This is a sample eBook. The eBook provides chapter-wise theories and examples, formulas, diagrams, and Exam pattern Problem-Solving of the full syllabus.



Complete video lectures

The theory and Problem-Solving in this eBook provide specially designed the video lectures by experienced faculties. Get Free trial and preview on Misostudy.com.

01. The Solid State

The solids are characterized by incompressibility, rigidity and mechanical strength. The molecules, atoms or ions in solids are closely packed i.e they are held together by strong forces and can not move about at random. Thus solids have definite volume, shape, low vapour pressure and possess the unique property of being rigid. Such solids are known as true solids e.g. NaCl, KCl, Sugar, Ag, Cu etc. On the other hand the solid which loses shape on long standing, flows under its own weight and is easily distorted by even mild distortion forces are called pseudo solids e.g. glass, plastic etc.

Some solids such as NaCl, Sugar, Sulphur etc. have properties not only of rigidity and incompressibility but also of having typical geometrical forms. These solids are called as crystalline solids. In such solids there is definite arrangement of particles (atoms, ions or molecules) throughout the entire three dimensional network of a crystal. This is named as long-range order. This three dimensional arrangement is called **crystal lattice or space lattice**. Other solids such as glass, rubber, plastics etc. have rigidity and incompressibility to a certain extent but they do not have definite geometrical forms or do not have long range order are known as amorphous solids.

02. Differences Between Crystalline and Amorphous Solids

(i). Characteristic Geometry

In the crystalline solids the particles (atoms, ions, or molecules) are definitely and orderly arranged thus these have characteristic geometry while amorphous solids do not have characteristic geometry.

Melting Points

A crystalline solid has a sharp melting point i.e. it changes into liquid state at a definite temperature. On the contrary an amorphous solid does not have a sharp melting point.

Cooling curve

Amorphous solids show a smooth cooling curve while crystalline solids show two breaks in the cooling curve. In the case of crystalline solids two break points 'a' and 'b' appear. These points indicate the beginning and the end of the process of crystallization. In this time interval the temperature remains constant. This is due to the fact that during the crystallization process energy is liberated which compensates for the loss of heat thus the temperature remains constant.

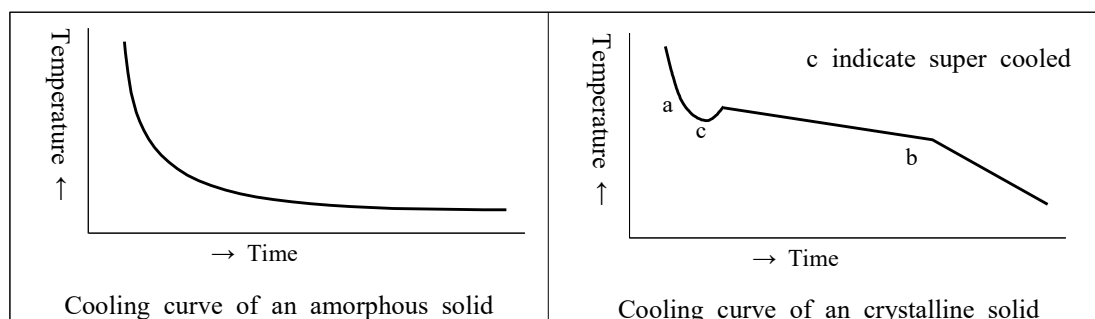

(i). **Isotropy and Anisotropy**

Amorphous solids differ from crystalline solids and resemble liquids in many respects. The properties of amorphous solids, such as electrical conductivity, thermal conductivity, mechanical strength, refractive index, coefficient of thermal expansion etc. are same in all directions. Such solids are known as isotropic. **Gases and liquids are also isotropic.**

On the other hand crystalline solids show these physical properties different in different directions. Therefore crystalline solids are called anisotropic.

03. Crystalline State

“A crystal is a solid composed of atoms (ions or molecules) arranged in an orderly repetitive array”

“**The smallest geometrical position of the crystal which can be used as repetitive unit to build up the whole crystal is called a unit cell.**” The unit cell should have same symmetry elements as the crystal and there should be no gaps between unit cells.

The angle between the two perpendiculars to the two intersecting faces is termed as the interfacial angle which may be same as the angle between the unit cell edges. Goniometer is used to measure the interfacial angle. It is important to note that interfacial angle of a substance remains the same although its shape may be different due to conditions of formation.

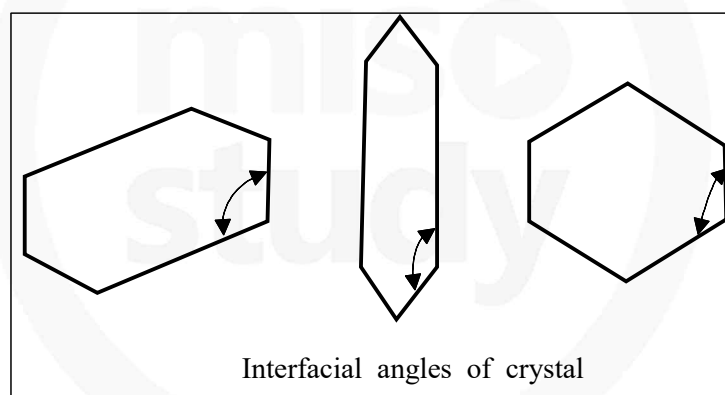

04. Types of the Crystals

Crystals are divided into four important types on the basis of chemical bonding of the constituent atoms.

(i) **Ionic Crystals**

These are formed by a combination of highly electro-positive ions (cations) and highly electronegative ions (anions). Thus strong electrostatic force of attraction acts within the ionic crystals. Therefore, a large amount of energy is required to separate ions from one another.

e.g. NaCl, KF, CsCl etc.

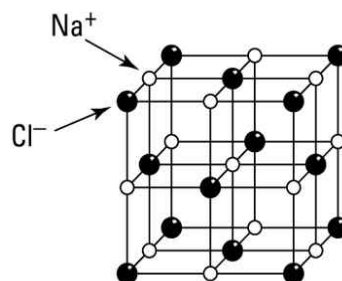

(ii) **Covalent Crystals**

These are formed by sharing of valence electrons between two atoms resulting in the formation of a covalent bond. The covalent bonds extend in two or three dimensions forming a giant interlocking structure called network. Diamond and graphite are the good examples of this type.

(iii) **Molecular Crystals**

In these crystals, molecules occupy the lattice points of the unit cells, except in solidified noble gases in which the units are atoms, where the binding is due to vander Waal's forces and dipole-dipole forces. Since vander Waal's forces are non-directional hence structure of the crystal is determined by geometric consideration only. Solid H_2 , N_2 , O_2 , CO_2 , I_2 , sugar etc. are well known examples of such crystal in which vander Waal's forces are acting.

(iv) **Metallic Crystals**

These are formed by a combination of atoms of electropositive elements. These atoms are bound by metallic bonds. It may be defined as:
The force that binds a metal ion to a number of electrons within its sphere of influences is known as metallic bond.

05. Isomorphism

The occurrence of a given substance in more than one solid crystalline forms have different physical properties is known as polymorphism. This property when occurs in elements is known as allotropy.

Sometimes we come across examples of chemically different solids which crystalline in the crystalline shape. Such substances are said to be Isomorphous (same shape). Their chemical constitutions are very similar and in some cases crystals of one substance may continue to grow when placed in a saturated solution of the other e.g. potash alum and chrome alum crystals have the same shape and can be grown in each other's solutions.

06. SPACE LATTICE/CRYSTALLINE LATTICE/3-D LATTICE

Space lattice is a regular arrangement of lattice points showing how the particles are arranged at different sites in 3D-view.

“The three dimensional distribution of component particles in a crystal can be found by X-ray diffraction of different faces of the crystal. On the basis of the classification of symmetry, the crystals have been divided into seven systems. These can be grouped into 32 classes which in turn can be regrouped into 7 crystal systems. These seven systems with the characteristics of their axes (angles and intercepts) along with some examples of each are given in the following table.

The Seven Crystal System

Name of system		Axes	Angles	Bravais Lattices
1.	Cubic [Isometric]	$a = b = c$	$\alpha = \beta = \gamma = 90^\circ$	Primitive, Face-centred, Body centred = 3
2.	Tetragonal	$a = b \neq c$	$\alpha = \beta = \gamma = 90^\circ$	Primitive, Body centred = 2
3.	Rhombohedral or Trigonal	$a = b = c$	$\alpha = \beta = \gamma \neq 90^\circ$	Primitive = 1
4.	Orthorhombic or Rhombic	$a \neq b \neq c$	$\alpha = \beta = \gamma = 90^\circ$	Primitive, Face-centred, Body centred End centred = 4
5.	Monoclinic	$a \neq b \neq c$	$\alpha = \gamma = 90^\circ$; $\beta \neq 90^\circ$	Primitive, End – centred = 2
6.	Triclinic	$a \neq b \neq c$	$\alpha \neq \beta \neq \gamma \neq 90^\circ$	Primitive = 1
7.	Hexagonal	$a = b \neq c$	$\alpha = \beta = 90^\circ$ $\gamma = 120^\circ$	Primitive = 1 Total = 14

07. Types of Unit Cells

There are four types of unit cells (among the cubic system).

(a) Simple or primitive. Particles are only at the corners of the unit cell.

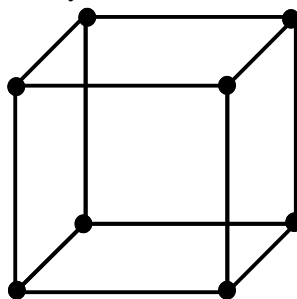

- (b) Face-centred cubic unit cell. A particle is present at the centre of each face of the unit cell.

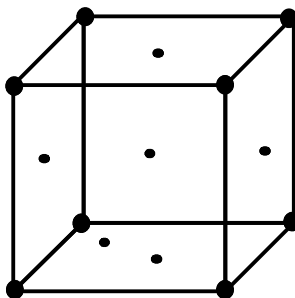

- (c) End-face-centred cubic unit cell. A particle is present at each corner plus particles are present on the end faces of the unit cell.

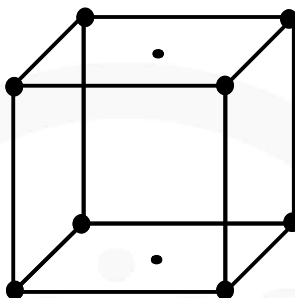

- (d) Body-centred cubic unit cell. In addition to the particles at the corners, there is one particle in the body-centre of the unit cell.

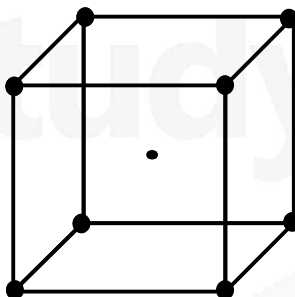

08. Coordination Number

If atoms are represented by spheres, the number of spheres which are touching a particular sphere is called *coordination number* of that sphere. In ionic crystals, the coordination number may be defined as the number of the oppositely charged ions surrounding a particular ion.

09. The number of particles per Unit Cell

- (i) An atom at the corner is shared by 8 unit cells. Therefore, its contribution is = $1/8$.
- (ii) An atom at the face is shared by 2 unit cells. Therefore, its contribution is = $1/2$.
- (iii) An atom present in the body is unshared. Therefore, its contribution is 1.
- (iv) An atom present on the edge is shared by four unit cells. Therefore, its contribution is = $1/4$. Thus, in
- (v) a primitive or simple cubic unit cell, the total number of particles is $1/8 \times 8 = 1$.
- (vi) a face-centred cubic unit cell; the total number of particles is $1/8 \times 8 + 1/2 \times 6 = 4$.
- (vii) a body-centred cubic unit cell, the total number of particles is $1/8 \times 8 + 1 = 2$.

The number of atoms per unit cell are in the same ratio as the stoichiometry of the compound or the ratio of the number of particles A and B present per unit cell gives the formula of the compound formed between A and B.

10. LENGTH OF FACE DIAGONAL AND CUBE DIAGONAL

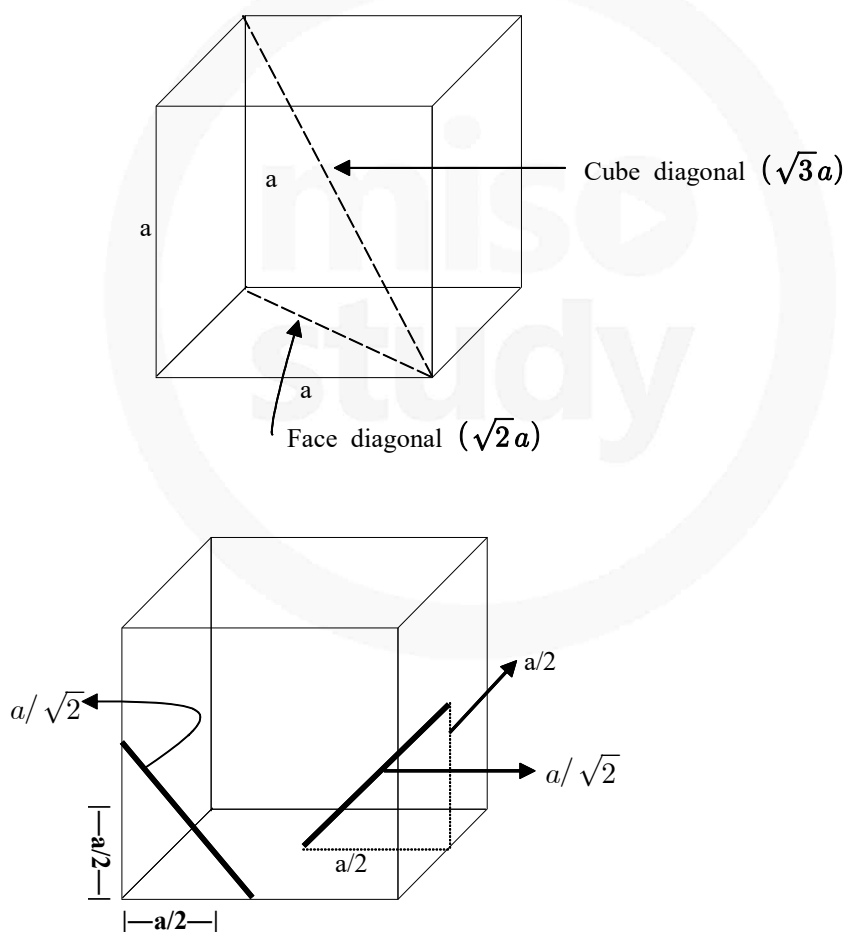

Consider the triangle ABC, with the help of pythagoras theorem

$$AC = \sqrt{AB^2 + BC^2} = \sqrt{a^2 + a^2} = \sqrt{2}a \quad (\text{length of face diagonal.})$$

Consider the triangle DAC, with the help of pythagoras theorem

$$DC = \sqrt{DA^2 + AC^2} = \sqrt{a^2 + (\sqrt{2}a)^2} = \sqrt{3}a \quad (\text{length of cube diagonal})$$

TYPES OF UNIT CELL (BRAVAIS LATTICE)

The distance between successive lattice planes of the same type is called the spacing of planes or inter planar distance between the planes. On the basis of this aspect, the lattices may be divided in following classes.

11. Simple/Primitive/Basic Unit cell

A unit cell having lattice point only at corners called as primitive or simple unit cell. i.e. in this case there is one atom at each of the eight corners of the unit cell considering an atom at one corner as the centre, it will be found that this atom is surrounded by six equidistant neighbours (atoms) and thus the co-ordination number will be six. If 'a' is the side of the unit cell, then the distance between the nearest neighbours shall be equal to 'a'.

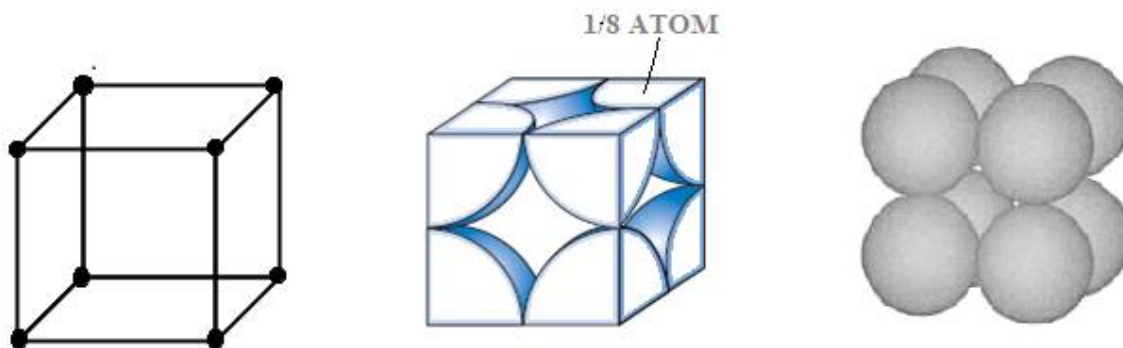

(a) Relationship between edge length 'a' and atomic radius 'r' :

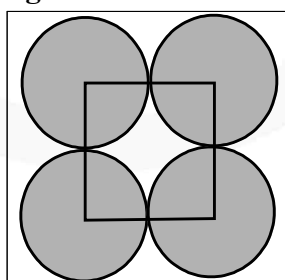

$$a=2r$$

$$\text{i.e. } r = \frac{a}{2} \quad (\text{One face of SCC})$$

(b) Number of atoms present in unit cell

In this case one atom or ion lies at the each corner. Hence simple cubic unit cell contains a total of $\frac{1}{8} \times 8 = 1$ atom or ion/unit cell.

(c) Packing efficiency(P. E.)

$$\text{P.E.} = \frac{\text{Volume occupied by atoms present in unit cell}}{\text{Volume of unit cell}}$$

$$= \frac{n \times \frac{4}{3} \pi r^3}{V} \quad [\because \text{Volume of atom} = \frac{4}{3} \pi r^3]$$

$$\text{For SCC : P.E.} = \frac{1 \times \frac{4}{3} \times \pi \times \left(\frac{a}{2}\right)^3}{a^3} \quad [\because r = \frac{a}{2} \text{ and } V = a^3, n = 1]$$

$$= \frac{\pi}{6} = 0.524 \text{ or } 52.4\%$$

12. Body centred cubic (b.c.c.) cell:

A unit cell having lattice point at the body centre in addition to the lattice point at every corner is called as body centered unit cell.

Here the central atom is surrounded by eight equidistant atoms and hence the co-ordination number is eight. The nearest distance between two atoms will be $\frac{a\sqrt{3}}{2}$

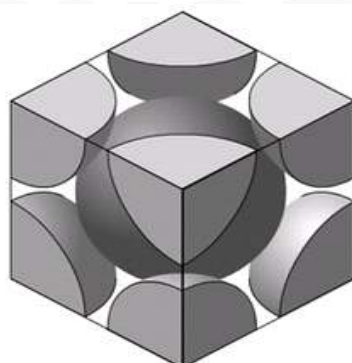

(a) Relationship between edge length 'a' and atomic radius 'r' :

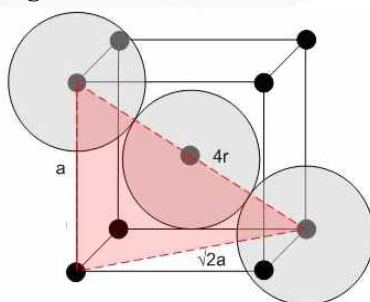

In BCC, along cube diagonal all atoms touches each other and the length of cube diagonal is $\sqrt{3}a$

$$\text{So, } \sqrt{3}a = 4r \quad \text{i.e. } r = \frac{\sqrt{3}a}{4}$$

(b) **Number of atom present in unit cell:**

$$\left(\frac{1}{8} \times 8\right) + (1 \times 1) = 1 + 1 = 2 \text{ atoms/unit cell}$$

In this case one atom or ion lies at the each corner of the cube. Thus contribution of the 8 corners is $\left(\frac{1}{8} \times 8\right) = 1$, while that of the body centred is 1 in the unit cell. Hence total number of atoms per unit cell is $1 + 1 = 2$ atoms (or ions)

(c) **Packing efficiency:**

$$\text{P.E.} = \frac{n \times \frac{4}{3} \pi r^3}{V} = \frac{2 \times \frac{4}{3} \times \pi \left(\frac{\sqrt{3}a}{4}\right)^3}{a^3} = \frac{\sqrt{3}\pi}{8} = 0.68 \quad \left[\because n = 2, r = \frac{\sqrt{3}a}{4}, V = a^3 \right]$$

In B.C.C. 68% of total volume is occupied by atom or ions.

13. Face centred cubic (f.c.c.) cell:

A unit cell having lattice point at every face centre in addition to the lattice point at every corner called as face centred unit cell. i.e. in this case there are eight atoms at the eight corners of the unit cell and six atoms at the centre of six faces. Considering an atom at the face centre as origin, it will be found that this face is common to two cubes and there are twelve points surrounding it situated at a distance which is equal to half the face diagonal of the unit cell. Thus the co-ordination number will be twelve and the distance between the two nearest atoms will be $\frac{a}{\sqrt{2}}$.

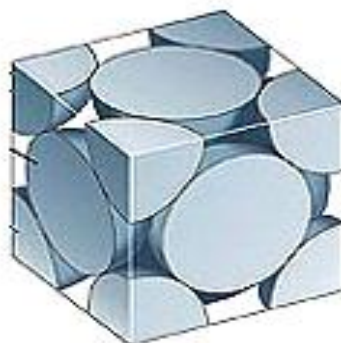

(a) **Relationship between edge length 'a' and atomic radius 'r' :**

In FCC, along the face diagonal all atoms touches each other and the length of face diagonal is $\sqrt{2}a$.

$$\text{So } 4r = \sqrt{2}a \quad \text{i.e. } r = \frac{\sqrt{2}a}{4} = \frac{a}{2\sqrt{2}}, \quad r = \frac{a}{2\sqrt{2}}$$

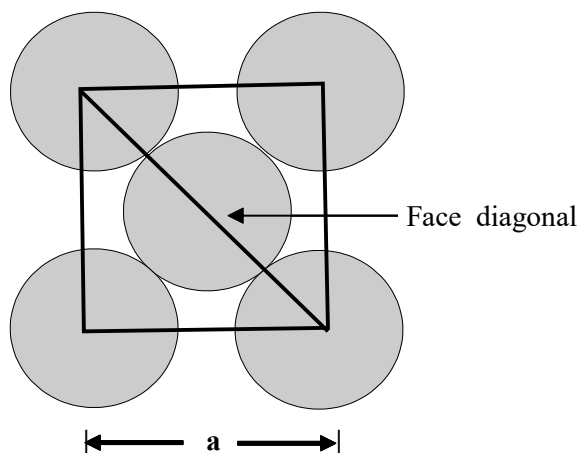

(b) **Number of atoms per unit cell :**

$$\left(\frac{1}{8} \times 8\right) + \left(6 \times \frac{1}{2}\right) = 1 + 3 = 4 \text{ atoms/unit cell}$$

In this case one atom or ion lies at the each corner of the cube and one atom or ion lies at the centre of each face of the cube. It may noted that only $\frac{1}{2}$ of each face sphere lie with in the unit cell and there are six such faces. The total contribution of 8 corners is $\left(\frac{1}{8} \times 8\right) = 1$, while that of 6 face centred atoms is $\left(\frac{1}{2} \times 6\right) = 3$ in the unit cell.

Hence total number of atoms per unit cell is $1+3 = 4$ atoms (or ions).

(c) **Packing efficiency :**

$$\begin{aligned} \text{P.E.} &= \frac{n \times \frac{4}{3} \pi r^3}{V} \quad \left[\because \text{for FCC } n = 4, r = \frac{a}{2\sqrt{2}}, V = a^3 \right] \\ &= \frac{4 \times \frac{4}{3} \pi \times \left(\frac{a}{2\sqrt{2}}\right)^3}{a^3} = \frac{\pi}{3\sqrt{2}} = 0.74 \text{ or } 74\% \end{aligned}$$

i.e. In FCC, 74% of total volume is occupied by atoms.

14. End Centered Unit Cell:

A unit cell having lattice point at the centres of only. one set of opposite faces in addition to the lattice point at every corner called as end centered unit cell.

NOTE This type of Bravais lattice is obtained only in orthorhombic and monoclinic type unit cell.

15. CRYSTAL DENSITY OF THE CRYSTAL

If the length of edge of the unit cell is known we can calculate the density of the crystal as follow: Let length of edge of the unit cell be ℓ .

$$\therefore \text{Volume of the unit cell} = \ell^3 = V \text{ cm}^3$$

$$\text{Density of the unit cell} = \frac{\text{Mass of unit cell}}{\text{Volume of unit cell}}$$

Mass of the unit cell = Number of atoms present in a unit cell \times Mass of one atom = $n \times m$ g

$$\text{But mass of one atom (m)} = \frac{\text{Atomic mass}}{\text{Avogadro Number}} = \frac{M}{N_A}$$

$$\text{Mass of the unit cell} = n \times \frac{M}{N_A} \text{ g}$$

$$\text{Density of the unit cell} = \frac{n \times \frac{M}{N_A}}{V} \text{ gm cm}^{-3}$$

$$\text{Density of the unit cell} = \frac{n \times M}{V \times N_A} \text{ g cm}^{-3} = \text{Crystal density (p)}$$

Example An element (atomic mass = 60) having face centred cubic crystal has a density of 6.23 g cm^{-3} . What is the edge length of the unit cell (Avogadro constant, $N_A = 6.02 \times 10^{23} \text{ mol}^{-1}$).

Solution

$$\text{Density} = \frac{Z \times M}{a^3 \times N_A} \quad Z = 4 \text{ (for fcc)}$$

$$6.23 = \frac{4 \times 60}{a^3 \times 6.022 \times 10^{23}} \quad a^3 = \frac{4 \times 60}{6.23 \times 6.022 \times 10^{23}}$$

$$= 64 \times 10^{-24}$$

$$a = 4 \times 10^{-8} \text{ cm}$$

$$= 4 \times 10^{-10} \text{ m} = 400 \text{ pm.}$$

16. Close packing

It is type of packing with maximum packing fraction & space utilization. The constituent particles of a solid are like hard spheres. These spheres can pack in space in various manner to form a packing. To clearly understand the packing of these spheres, the packing can be categorised as :

- (i) Close packing in one dimension.
- (ii) Close packing in two dimension.
- (iii) Close packing in three dimension.

17. Close packing in one dimension :

In one dimension, only one arrangement of spheres is possible as shown in fig.

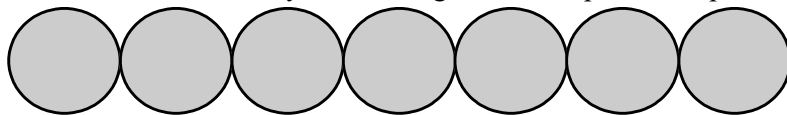

Close packing of spheres in one dimension

Two dimensional packing of spheres :

Two possible types of two dimensional packing are.

- (i) Square close packing in two dimension.
- (ii) Hexagonal close packing in two dimension.

18. Two dimensional square packing of spheres :

When two rows are placed in such a manner, that spheres of one row are placed immediately below of the other, the resulting packing is called two dimensional square close packing.

- (i) Since all the rows are identical the packing is called AAA type packing.
- (ii) Each sphere is touched by four other hence coordination number is four.
- (iii) Of centres of spheres are connected, square cells are formed, hence also called two dimensional square packing.
- (iv) This type of packing is not very effective in terms of utilization of space.

(v) Packing efficiency in 2-D = $\frac{1 \times \pi r^2}{a^2} = \frac{1 \times \pi (a/2)^2}{a^2} = \frac{\pi}{4} = 0.74$.

(vi) Packing efficiency in 3-D = $\frac{1 \times \frac{4}{3} \pi \left(\frac{a}{2}\right)^3}{a^3} = 0.52$ [In 3-D its unit cell is simple cubic]

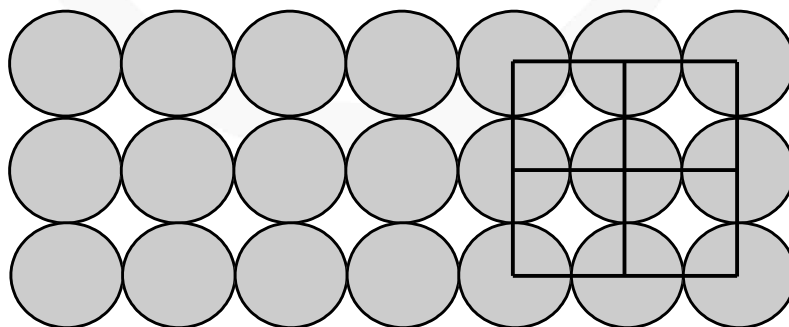

19. Two dimensional hexagonal packing :

If various one dimensional close pack rows are placed in such a way that spheres of top row fits in depression of bottom row spheres, the resulting packing is called two dimensional close packing structure.

- (i) Every third row sphere comes exactly at top of first row sphere, hence the packing is called ABABAB packing.
- (ii) If centres are joined, hexagonal unit cells are formed. Hence this is called two dimensional hexagonal close packing.
- (iii) This packing is most efficient in utilizing space in two dimensional arrangement.
- (iv) Each sphere is touched by six other, hence coordination number is six.

$$(v) \text{ Packing efficiency in 2-D} = \frac{3 \times \pi \left(\frac{a}{2}\right)^2}{\frac{a^3 \sqrt{3}}{4} \times 6} = \frac{\pi}{2\sqrt{3}} = 0.91$$

$$(vi) \text{ Packing efficiency in 3-D} = \frac{3 \times \frac{4}{3} \pi \left(\frac{a}{2}\right)^3}{\frac{a^2 \sqrt{3}}{4} \times 6 \times a} = \frac{\pi}{3\sqrt{3}} = 0.60$$

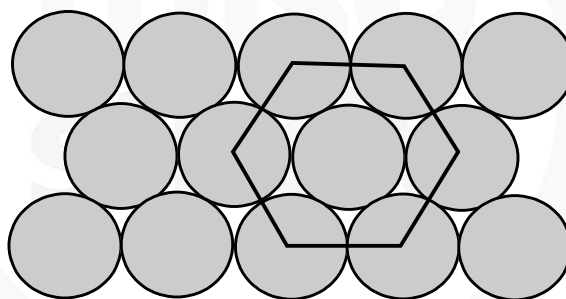

20. Close packing in three dimensions :

When two dimensional packing structure are arranged one above the other, depending upon type of two dimensional arrangement in a layer, and the relative positions of spheres in above or below layer, various types of three dimensional packing results. To define 3-D lattice six lattice parameters are required – 3 edge lengths & 3 angles.

- (i) Simple cubic packing (A A A A)
- (ii) Hexagonal close packing (AB AB AB
- (iii) Cubic close packing or face centered cubic (...ABC ABC...)

21. Simple cubic packing in three dimension :

The two dimensional square close packed layer are placed, in such a manner that spheres in each layer comes immediately on top of below layer, simple cubic packing results. Important points.

- (i) Atoms all aligned vertically and horizontally in all directions.
- (ii) The unit cell for this packing is simple cubic unit cell.
- (iii) In this packing, only 52% of available space is occupied by atoms.

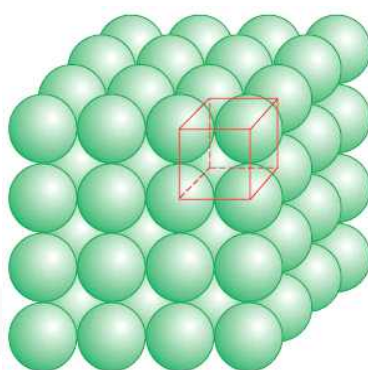

22. Three Dimensionally close packing :

In hexagonal close packing, there are two types of the voids (open space or space left) which are divided into two sets 'b' and 'c' for convenience. The spaces marked 'c' are curved triangular spaces with tips pointing upwards whereas spaces marked 'b' are curved triangular spaces with tips pointing downwards. Now we extend the arrangement of spheres in three dimensions by placing second close packed layer (hexagonal close packing) (B) on the first layer (A). The spheres of second layer may placed either on space denoted by 'b' or 'c'. It may be noted that it is not possible to place sphered on both types of voids (i.e. b and c). Thus half of the voids remain unoccupied by the second layer. The second layer also have voids of the types 'b' and in order to build up the third layer, there are following two ways :

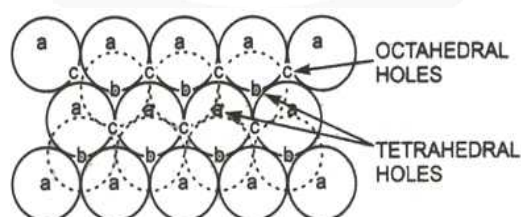

23. Hexagonal close packing (HCP) AB-AB-AB Type :

- (i) In one way, the spheres of the third layer lie on spaces of second layer (B) in such a way that they lie directly above those in the first layer (A). In other words we can say that the layer becomes identical to the first layer. If this arrangement is continued indefinitely in the same order this represented as A B A B A B
This type of arrangement represent hexagonal close packing (hcp) symmetry (or structure), which means that the whole structure has only one 6-fold axis of symmetry i.e. the crystal has same appearance on rotation through an angle of 60° .
- (ii) Every third layer sphere lies on top of first layer sphere. (ABABAB packing)
- (iii) Maximum possible space is occupied by spheres.
- (iv) Each sphere is touched by 12 other spheres in 3D
(6 in one layer, 3 in top layer and 3 in bottom.)
- (v) The unit cell for hexagonal close packing is hexagonal unit cell.
- (vi) For every atom forming hcp there are effectively two tetra voids and one octa void.
That why this generate ABAB AB pattern. One type of void always remain on unoccupied.

Unit cell : $a = 2r = b$; $\gamma = 120^\circ$

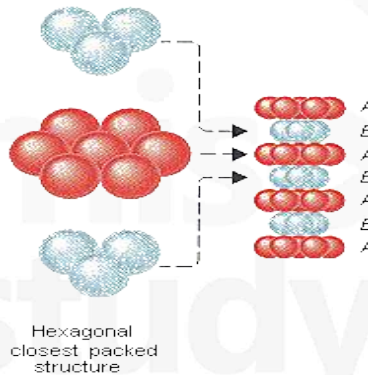

(vii) Packing efficiency of HCP units

Relation between a, b, c and R :

$$a = b = 2R$$

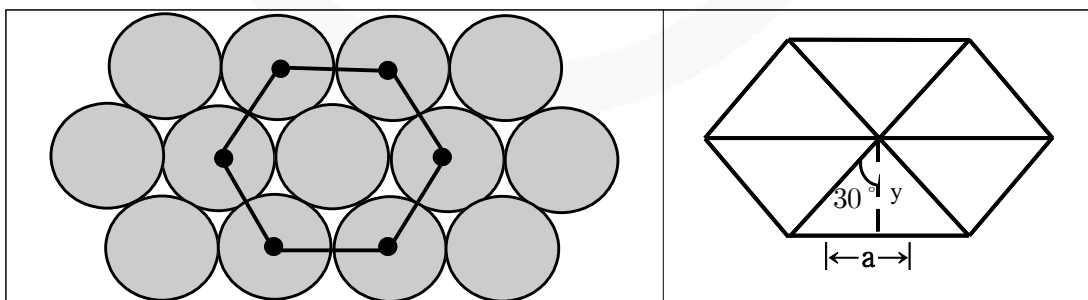

$$\tan 30 = \frac{a}{2 \times y}$$

so

$$y = \frac{a \times \sqrt{3}}{2 \times 1} = \frac{\sqrt{3}}{2} a.$$

$$\text{Area} = 6 \left[\frac{1}{2} a \times \frac{\sqrt{3}}{2} a \right] = \frac{6\sqrt{3}a^2}{4}$$

Calculation of c :

$$\cos 30^\circ = \frac{a}{2 \times x} \quad x = \frac{2a}{2 \times \sqrt{3}} = \frac{a}{\sqrt{3}}$$

Applying pythagoras theorem : $x^2 + h^2 = a^2$

$$\text{So } h^2 = a^2 - x^2 = a^2 - \frac{a^2}{3} = \frac{2}{3} a^2$$

$$h = \frac{2}{\sqrt{3}} a \quad \text{so } c = 2h = 2\sqrt{\frac{2}{3}} a$$

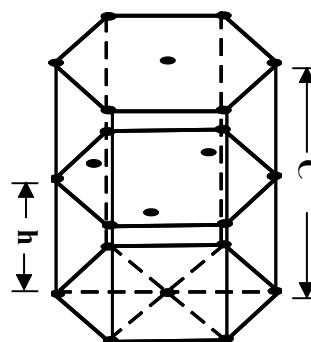
**24. ABC – ABC arrangement (Cubic close packing (FCC))**

In second way, the spheres of the third layer (C) lie on the second layer (B) in such a way that they lie over the unoccupied spaces 'C' of the first layer(A). If this arrangement is continuous in the same order this is represented as ABC ABC ABC..... This type of arrangement represent cubic close packed (ccp) structure. This structure has 3-fold axes of symmetry which pass through the diagonal of the cube. since in this system, there is a sphere at the centre of each face of the unit cell and hence this structure is also known as face-centred cubic (fcc) structure. It may be noted that in ccp (or fcc) structures each sphere is surrounded by 12 spheres hence the coordination number of each sphere is 12. The spheres occupy 74% of the total volume and 26% of is the empty space in both (hcp and ccp) structure.

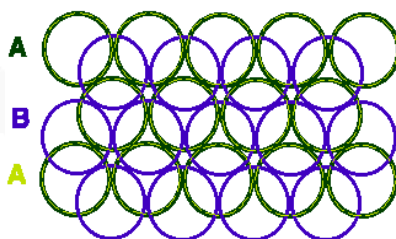

- IIIrd layer will be different from Ist layer as well as IInd layer.
- It is also known as cubical close packing (CCP), unit cell chosen is face centered unit cell (FCC).

Relation between 'a' and 'R' :

$$a \neq 2R \quad \sqrt{2}a = 4R \text{ (Sphere are touching along the face diagonal)}$$

$$\text{Effective no. of atoms per unit cell (Z)} = Z = \frac{1}{8} \times 8 + \frac{1}{2} \times 6 = 4$$

Packing fraction

$$\text{P.F.} = \frac{4 \times \frac{4}{3} \pi R^3}{4 \times 4 \times 4 R^3} \times \sqrt{2} \times 2 = \frac{\pi}{3\sqrt{2}} = 0.74 \text{ (74\%)}$$

Coordination number , (CN) = 12

$$\text{Density (d)} = \frac{Z \times M}{N_A \cdot a^3}$$

INTERSTICES OR VOIDS OR HOLES IN CRYSTALS

It has been shown that the particles are closely packed in the crystals even than there is some empty space left in between the spheres. This is known as interstices (or interstitial site or hole empty space or voids). In three dimensional close packing (CCP & HCP) the interstices are of two types : (i) tetrahedral interstices and (ii) octahedral interstices.

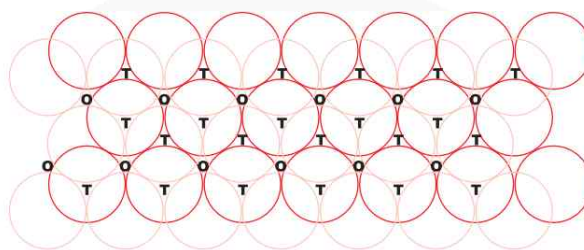
**25. Tetrahedral Interstices :**

We have seen that in hexagonal close packing (hcp) and cubic close packing (ccp) each sphere of second layer touches with three spheres of first layer. Thus they, leave a small space in between which is known as **tetrahedral site or interstices**. or The vacant space between 4 touching spheres is called as tetrahedral void. Since a sphere touches three spheres in the below layer and three spheres in the above layer hence there are two tetrahedral sites associated with one sphere. It may be noted that a tetrahedral site does not mean that the site is tetrahedral in geometry but it means that this site is surrounded by four spheres and the centres of these four spheres lie at the apices of a regular tetrahedron.

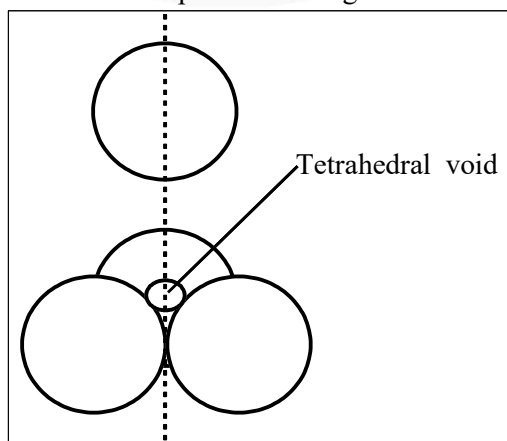

In FCC, one corner and its three face centred atom of faces meeting at that corner form a tetrahedral void.

In FCC, two tetrahedral voids are obtained along one cube diagonal. So in FCC 8 tetrahedral voids are present.

In FCC total number of atoms = 4

In FCC total number of tetrahedral voids = 8

So, we can say that, in 3D close packing 2 tetrahedral voids are attached with one atom.

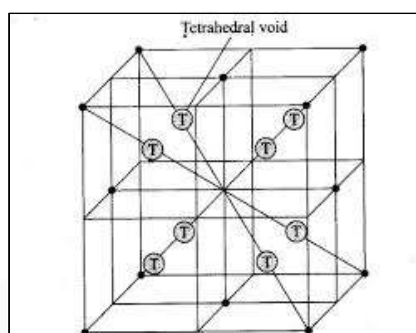

26. Octahedral – Interstices :

Hexagonal close packing (hcp) and cubic close packing (ccp) also form another type of interstices (or site) which is called octahedral site (or interstices). or The vacant space between 6 touching spheres is called as octahedral void.

In the figure two layers of close packed spheres are shown. The spheres of first layer are shown by full circles while that of second layer by dotted circles. Two triangles are drawn by joining the centres of three touching spheres of both the layers.

In FCC, 6 face centres form a octahedral void at body centre.

The apices of these triangles point are in opposite directions. On super imposing these triangles on one another a octahedral site is created. It may be noted that an octahedral site does not mean that the hole is octahedral in shape but it means that this site is surrounded by six nearest neighbour lattice points arranged octahedrally.

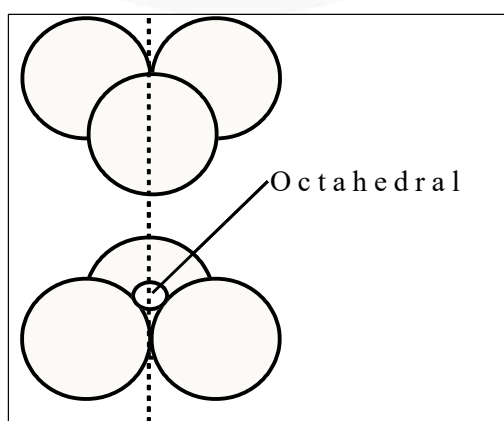

27. Positions of Tetrahedral Voids in an fcc Unit Cell :

The centre of tetrahedral void is located on the centre of body diagonal of each small cube of volume $\left(\frac{a^3}{8}\right)$.

$$\text{Total number of atoms per unit cell} = \frac{1}{2} \times 6 + 8 \times \frac{1}{8} = 4$$

Total number of tetra void = 8

Effective number of tetra void per atom forming close pack = 2.

If a fcc unit cell is divided into eight equal mini-cubes (edge = $a/2$) then centre of tetra voids lies at the centres of each of these mini-cubes. In FCC center of tetra void is at perpendicular distance of $a/4$ from nearest face.

28. Positions of Octahedral Voids in an fcc Unit Cell :

Position of octa void is at mid-point of each edge (total 12 edges in a cube) and at the centre of cube. Each octa void located at mid point of edge contributes $1/4$ to the unit cell. The octa void situated at the centre contributes 1.

In FCC, total number of octahedral voids are

$$(1 \times 1) + \left(12 \times \frac{1}{4}\right) = 1 + 3 = 4$$

(Cube centre) (edge)

In FCC, number of atoms = 4

In FCC, number of octahedral voids = 4

So, we can say that, in any type of close packing one octahedral void is attached with one atom.

29. Limiting Radius Ratios

An ionic crystal contains a large number of cations and anions. Generally cations are smaller in size than anions. The cations are surrounded by anions and they touch each other. These ions are arranged in space in such a way to produce maximum stability. The stability of the ionic crystal may be described in terms of radius ratio i.e. the ratio of the radius of cation (r) to that of anion (R) is (r/R) . The range of (r/R) may be expressed as limiting radius ratio. This value is important to determine the arrangement of the ion in different types of crystals.

Limiting radius ratio for various types of sites

Limiting radius ratio = r/R	Coordination Number of cation	Structural Arrangement (Geometry of voids)	Example
0.155 – 0.225	3	Plane Trigonal	Boron Oxide
0.225 – 0.414	4	Tetrahedral	ZnS, SiO ₂
0.414 – 0.732	4	Square planar	– .
0.414 – 0.732	6	Octahedral	NaCl, MgO ₂
0.732 – 1.000	8	Cubic	CsCl

Example A solid $A^+ B^-$ has NaCl type close packed structure. If the anion has a radius of 250 pm, what should be the ideal radius for the cation ? Can a cation C^+ having a radius of 180 pm be slipped into the tetrahedral site of the crystal $A^+ B^-$? Give reason for your answer.

Solution NaCl = FCC Closed packed structure

$$\frac{r_+(C^+)}{r_-(B^-)} = \frac{180\text{pm}}{250\text{pm}} = 0.72$$

It does not lie in the range 0.225–0.414. Hence, C^+ cannot be slipped into the tetrahedral site.

30. STRUCTURE of NaCl :

The bigger Cl^- forms cubic close packing and small Na^+ occupy positions of all octahedral voids. The radius ratio $\frac{r^+}{r^-}$ lie in the range 0.414 – 0.73.

- (i) Each Na^+ is surrounded by six Cl^- is surrounded by six Na^+ ion. [6:6 coordination]
- (ii) Total no. of Na^+ and Cl^- in each limit cell is 4.
- (iii) Number of formula units of NaCl per unit cell is equal to 4.

(iv) The density of NaCl crystal is given by $d = \left(\frac{4 \times M_{NaCl}}{N_A \times a^3} \right)$

N_A = Avogadro's number ; a = Edge length

The edge length of NaCl unit cell is given by $(2r^+ + 2r^-) \Rightarrow \frac{a}{2} = r^+ + r^-$ (FCC & Octa void)

31. Zinc Blende (Sphalerite) Structure :

Larger anions form ccp arrangement and smaller cations filling half of alternate tetrahedral voids.

- (i) C.N. of $Zn^{2+} = 4$; C.N. of $S^{2-} = 4$ [4 : 4 coordination]
- (ii) Formula units of ZnS per unit cell = 4.

(iii) $d_{ZnS} = \frac{4 \times M_{ZnS}}{N_A \times a^3}$

(iv) $r_{Zn^{2+}} + r_{S^{2-}} = \frac{a\sqrt{3}}{4}$

32. Cesium Halide Structure :

(CsCl) Cl^- at the corners of cube and Cs^+ in the center.

(i) C.N. of Cs^+ = 8 ; C.N. of Cl^- = 8 [8 : 8 coordination]

(ii) Formula units of CsCl per cube = 1

$$\text{(iii) } d_{\text{CsCl}} = \frac{M_{\text{CsCl}}}{N_A \times a^3}$$

$$\text{(iv) } r_{\text{Cs}^+} = r_{\text{Cs}^-} = \frac{a\sqrt{3}}{2} \Rightarrow r^+ + r^- = \frac{a\sqrt{3}}{4} \text{ (FCC \& tetra void)}$$

33. Fluorite Structure :

(CaF_2) Ca^{2+} forming ccp arrangement and F^- filling all tetrahedral voids.

(i) C.N. of F^- = 4 ; C.N. of Ca^{2+} = 8 [8 : 4 coordination]

(ii) Formula units of CaF_2 per unit cell = 4

$$\text{(iii) } d_{\text{CaF}_2} = \frac{4 \times M_{\text{CaF}_2}}{N_A \times a^3}$$

$$\text{(iv) } r_{\text{Ca}^{2+}} + r_{\text{F}^-} = \frac{a\sqrt{3}}{4}$$

34. Imperfections In Solid

Any deviation from the perfectly ordered arrangement constitutes a defect or imperfection. These defects sometimes called thermodynamic defect because the number of these defects depends on the temperature. Crystals may also possess additional defect due to the presence of impurities. Imperfection not only modify the properties of solids but also give rise to new properties.

35. Stoichiometric Defects

Those compounds in which the number of positive and negative ions are exactly in the ratio indicated by their chemical formula are called stoichiometric compounds. eg NaCl (1:1). These solids show following types of defects :

36. Schottky Defect :

This type of defect is created when same number of positive ion and negative ion are missing from their respective positions leaving behind a pair of holes. Schottky defect is more common in ionic compounds with high co-ordination number and where the size of positive and negative ions are almost equal. The presence of large number of schottky defects in crystal results in significant decrease in its density. Eg. NaCl, KCl, CsCl, KBr etc.

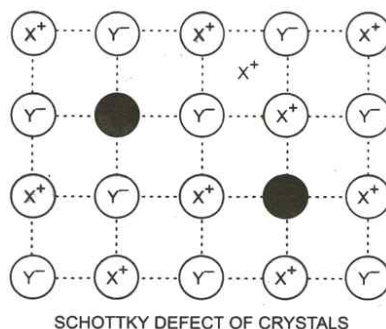

37. Interstitial Defect :

This type of defect is caused due to the presence of ions in the normally vacant interstitial sites in the crystal.

38. Frenkel Defect :

This type of defect is created when an ion leaves its correct lattice site and occupies an interstitial site. Frenkel defects are common in ionic compounds which have low co-ordination number and in which there is large difference in size between positive and negative ions. Eg. ZnS, AgCl, AgBr, Ag etc.

39. Non Stoichiometric Defect Frenkel Defect :

There are many compound in which the ratio of positive and negative ions present in the compound differs from that required by ideal formula of the compound. Such compounds are called Non stoichiometric compounds. eg. VO_x (Where x can vary between 0.6 to 1.3.) In these compounds balance of positive and negative charges is maintained by having extra electrons or extra positive charge. So, these defects are of following types:

40. Metal Excess Defects Due to Anion Vacancies

A compound may have excess metal ion if a negative ion is absent from its lattice site, leaving a hole which is occupied by electron to maintain electrical neutrality. The holes occupied by electrons are called F-centres and are responsible for the colour of the compound.

Eg.

- The excess sodium in NaCl makes the crystal appears yellow.
- Excess potassium in KCl makes it violet.
- Excess lithium in LiCl makes it Pink.
- Greater the number of F-centres greater is the intensity of colour. This type of defects are found in crystal which are likely to possess schottky defects.

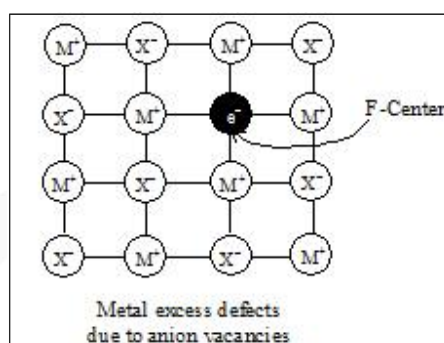

41. Metal Excess Defects Due to Interstitial Cations

It may occur if an extra positive ion is present in an interstitial site, Electrically neutrality is maintained by the presence of an electron in the interstitial site. This type of defects are exhibited by the crystals which are likely to exhibit "Frenkel defects". Eg. Yellow colour of ZnS.

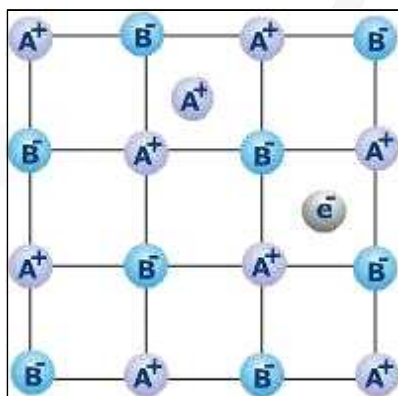

42. Metal Deficiency Due to Cation Vacancies

The non-stoichiometric compound may have metal deficiency due to the absence of a metal ion from its lattice site. The charge is balanced by an adjacent ion having higher positive charge. This type of defects are generally shown by compounds of transition metals.

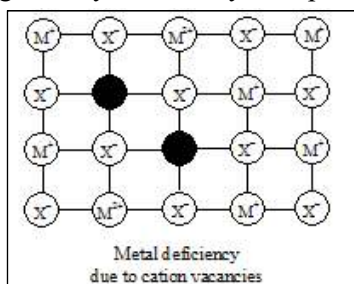

Example Analysis shows that nickel oxide has the formula $\text{Ni}_{0.98}\text{O}$. What fractions of the nickel exist as Ni^{2+} and Ni^{3+} ?

Solution Let Ni^{2+} be x so that Ni^{3+} will be $0.98-x$. Total charge on the compound must be zero so that

$$+ 2x + 3(0.98 - x) - 2 = 0$$

$$2x + 2.94 - 3x - 2 = 0$$

$$-x = - 0.94$$

$$\text{or } x = 0.94$$

$$\% \text{ of } \text{Ni}^{2+} = \frac{0.94}{0.98} \times 100 = 96\%$$

$$\% \text{ of } \text{Ni}^{3+} = 4\%$$

JEE Main Pattern Exercise (1)

- Q1. Sodium metal crystallizes in a body centered cubic lattice with a unit cell edge of 4.29\AA . The radius of sodium atom is approximately.
- 1.86\AA
 - 3.22\AA
 - 5.72\AA
 - 0.93\AA
- Q2. CsCl crystallizes in body centred cubic lattice. If 'a' its edge length, then which of the following expressions is correct?
- $r_{\text{Cs}^+} + r_{\text{Cl}^-} = 3a$
 - $r_{\text{Cs}^+} + r_{\text{Cl}^-} = \frac{3a}{2}$
 - $r_{\text{Cs}^+} + r_{\text{Cl}^-} = \frac{\sqrt{3}}{2}a$
 - $r_{\text{Cs}^+} + r_{\text{Cl}^-} = \sqrt{3}a$
- Q3. Experimentally it was found that a metal oxide has formula $M_{0.98}\text{O}$. Metal M , present as M^{2+} and M^{3+} in its oxide. Fraction of the metal which exists as M^{3+} would be
- 7.01%
 - 4.08%
 - 6.05%
 - 5.08%
- Q4. Which of the following exists as covalent crystals in the solid state?
- Iodine
 - Silicon
 - Sulphur
 - Phosphorus
- Q5. In FCC unit cell, what fraction of edge is not covered by atoms?
- 0.134
 - 0.24
 - 0.293
 - None of these

Q6. The packing efficiency of two-dimensional square unit cell shown below is

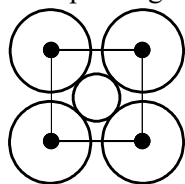

- (a) 39.27% (c) 74.05%
(b) 68.02% (d) 78.54%

Q7. A substance A_xB_y crystallizes in a face centred cubic (fcc) lattice in which atoms A occupy each corner of the cube and atoms B occupy the centres of each face of the cube. Identify the correct composition of the substance A_xB_y

- (a) AB_3
(b) A_4B_3
(c) A_3B
(d) composition cannot be specified

Q8. The coordination number of a metal crystallizing in a hexagonal close-packed structure is

- (a) 12
(b) 4
(c) 8
(d) 6

Q9. Which of the following fcc structure contains cations in alternate tetrahedral voids?

- (a) NaCl
(b) ZnS
(c) Na_2O
(d) CaF_2

Q10. A solid is formed and it has three types of atoms X, Y, Z. X forms a FCC lattice with Y atoms occupying all the tetrahedral voids and Z atoms occupying half the octahedral voids. The formula of the solid is:

- (a) XY_2Z
(b) XY_2Z_4
(c) X_2Y_4Z
(d) X_4YZ_2



Answer & Solution

ANSWER

Q1	Q2	Q3	Q4	Q5
(a)	(c)	(b)	(b)	(c)
Q6	Q7	Q8	Q9	Q10
(d)	(a)	(a)	(b)	(c)

miso
study

JEE Advanced Pattern Exercise (1)

- Q1. The correct statement(s) regarding defects in solids is/are
- Frenkel defect is usually favoured by a very small difference in the sizes of cation and anion
 - Frenkel defect is a dislocation defect
 - Trapping of an electron in the lattice leads to the formation of F-centre
 - Schottky defects have no effect on the physical properties of solids

Q2. **Assertion and Reason**

- Statement I is correct Statement II is correct Statement II is the correct explanation of Statement I
- Statement I is correct Statement II is correct Statement II is not the correct explanation of Statement I
- Statement I is correct Statement II is incorrect
- Statement I is incorrect Statement II is correct

Statement I

In any ionic solid (MX) with Schottky defects, the number of positive and negative ions are same.

Statement II

Equal numbers of cation and anion vacancies are present.

In hexagonal systems of crystals, a frequently encountered arrangement of atoms is described as a hexagonal prism. Here, the top of bottom of the cell are regular hexagons and three atoms are sandwiched in between them. A space-filling model of this structure, called hexagonal close-packed (hcp), is constituted of a sphere on a flat surface surrounded in the same plane by six identical spheres as closely as possible. Three spheres are then placed over the first layer so that they touch each other and represent the second layer. Each one of these three spheres touches three spheres of the bottom layer. Finally, the second layer is covered with a third layer that is identical to the bottom layer in relative position.

- Q3. The number of atoms in one of this hcp unit cell is

- 4
- 6
- 12
- 17

- Q4. The volume of this hcp unit cell is

- $24\sqrt{2}r^3$
- $16\sqrt{2}r^3$
- $12\sqrt{2}r^3$
- $\frac{64r^3}{3\sqrt{3}}$

Q5. The empty space in this hcp unit cell is

- (a) 74%
- (b) 47.6
- (c) 32%
- (d) 26%

Q6. Match the crystal system/unit cells mentioned in Column I with their characteristic features mentioned in Column II.

Column I		Column II	
A.	Simple cubic and face centred cubic	p.	have these cell parameters $a=b=c$ and $\alpha = \beta = \gamma = 90^\circ$
B.	Cubic and rhombohedral	q.	are two crystal systems
C.	Cubic and tetragonal	r.	have only two crystallographic angles of 90°
D.	Hexagonal and monoclinic	s.	belong to same crystal system

Q7. In FCC unit cell, what fraction of edge is not covered by atoms?

- (a) 0.134
- (b) 0.24
- (c) 0.293
- (d) None of these

Q8. Silver (atomic weight = 108 g mol^{-1}) has a density of 10.5 g cm^{-3} . The number of silver atoms on a surface of area 10^{-12} m^2 can be expressed in scientific notation as $y \times 10^x$. The value of x is

Q9. Which of the following Statement (s) is/are correct?

- (a) The coordination number of each type of ion in CsCl crystal is 8
- (b) A metal that crystallizes in bcc structure has a coordination number of 12
- (c) A unit cell of an ionic crystal shares some of its ions with other unit cells
- (d) The length of the unit cell in NaCl is 552 pm. ($r_{\text{Na}^+} = 95 \text{ pm}$; $r_{\text{Cl}^-} = 181 \text{ pm}$)

Q10. The packing efficiency of two-dimensional square unit cell shown below is

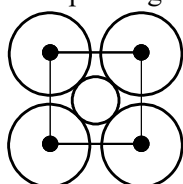

- (a) 39.27%
- (b) 68.02%
- (c) 74.05%
- (d) 78.54%



Answer & Solution

ANSWER

Q1	Q2	Q3	Q4	Q5
(b), (c)	(a)	(b)	(a)	(d)
Q6	Q7	Q8	Q9	Q10
(A) - p , s (B) - q (C) - q (D) - q , r	(c)	7	(a), (c), (d)	(d)

JEE

MATHEMATICS

- ▶ Specially designed eBook for complete JEE syllabus
- ▶ JEE preparation strategy & direction, speedy revision
- ▶ Chapter-wise important Problem-Solving
- ▶ Theory, Formulas & Diagrams to crack JEE
- ▶ Detailed high quality video lectures by experienced faculties
- ▶ JEE full preparation for Class XI & XII



misostudy
connect smart learning

JEE·NEET·AIIMS·CBSE·FOUNDATION
www.misostudy.com

☎ 8929803804 (MON-FRI: 9am-6pm) support@misostudy.com

MISO STUDY INDIA PVT. LTD.
2ND FLOOR 65-A, OMPRO TOWER, KALU SARAI, NEW DELHI, DELHI 110016

Geometric Representation

Class 12 | Mathematics

03 Relations & Functions

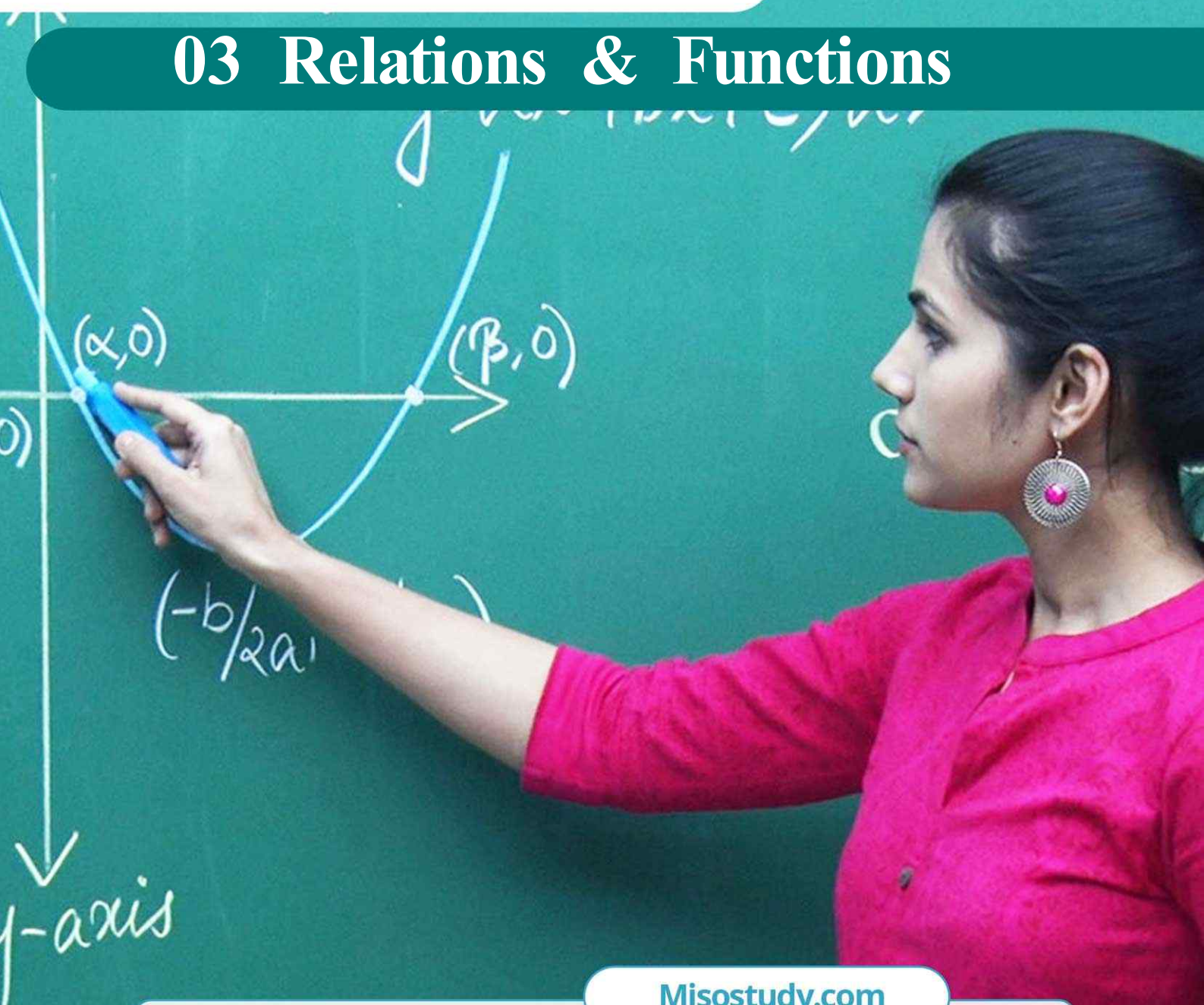

Misostudy.com



Scientific eBook

This is a sample eBook. The eBook provides chapter-wise theories and examples, formulas, diagrams, and Exam pattern Problem-Solving of the full syllabus.



Complete video lectures

The theory and Problem-Solving in this eBook provide specially designed the video lectures by experienced faculties. Get Free trial and preview on Misostudy.com.

01. Types of Relations

(A) VOID, UNIVERSAL AND IDENTITY RELATIONS

Void Relation-

Let A be a set. Then, $\phi \subseteq A \times A$ and so it is a relation on A . This relation is called the void or empty relation on set A .

Universal Relation-

Let A be a set. Then, $A \times A \subseteq A \times A$ and so it is a relation on A . This relation is called the universal relation on A .

NOTE  It is to note here that the void relation and the universal relation on a set A are respectively the smallest and the largest relations on set A . Both the empty (or void) relation and the universal relation are sometimes. They are called trivial relations.

Identity Relation-

Let A be a set. Then, the relation $I_A = \{(a, a) : a \in A\}$ on A is called the identity relation on A .

In other words, a relation I_A on A is called the identity relation i.e., if every element of A is related to itself only.

(B) REFLEXIVE, SYMMETRIC, TRANSITIVE, ANTISYMMETRIC RELATIONS

Reflexive Relation-

A relation R on a set A is said to be reflexive if every element of A is related to itself.

Thus, R is reflexive $\Leftrightarrow (a, a) \in R$ for all $a \in A$.

A relation R on a set A is not reflexive if there exists an element $a \in A$ such that $(a, a) \notin R$.

Symmetric Relation-

A relation R on a set A is said to be a symmetric relation iff

$(a, b) \in R \Rightarrow (b, a) \in R$ for all $a, b \in A$

i.e. $aRb \Rightarrow bRa$ for all $a, b \in A$.

Transitive Relation-

Let A be any set. A relation R on A is said to be a transitive relation iff

$(a, b) \in R$ and $(b, c) \in R$

$\Rightarrow (a, c) \in R$ for all $a, b, c \in A$.

i.e. aRb and bRc

$\Rightarrow aRc$ for all $a, b, c \in A$.

Antisymmetric Relation-

Let A be any set. A relation R on set A is said to be an antisymmetric relation iff

$(a, b) \in R$ and $(b, a) \in R \Rightarrow a = b$ for all $a, b \in A$

NOTE  It follows from this definition that if $(a, b) \in R$ and $(b, a) \notin R$, then also R is an antisymmetric relation.

(C) Equivalence Relation

A relation R on a set A is said to be an equivalence relation on A iff

- (i) it is reflexive i.e. $(a, a) \in R$ for all $a \in A$
- (ii) it is symmetric i.e. $(a, b) \in R \Rightarrow (b, a) \in R$ for all $a, b \in A$
- (iii) it is transitive i.e. $(a, b) \in R$ and $(b, c) \in R \Rightarrow (a, c) \in R$ for all $a, b, c \in A$.

02. Some Results on Relations

RESULT 1

If R and S are two equivalence relations on a set A , then $R \cap S$ is also an equivalence relation on A .

OR

The intersection of two equivalence relations on a set is an equivalence relation on the set.

RESULT 2

The union of two equivalence relations on a set is not necessarily an equivalence relation on the set.

RESULT 3

If R is an equivalence relation on a set A , then R^{-1} is also an equivalence relation on A .

OR

The inverse of an equivalence relation is an equivalence relation.

03. Kinds of Functions

ONE-ONE FUNCTION (INJECTION)

A function $f : A \rightarrow B$ is said to be a one-one function or an injection if different elements of A have different images in B .

Thus, $f : A \rightarrow B$ is one-one

$$\Leftrightarrow a \neq b \Rightarrow f(a) \neq f(b) \text{ for all } a, b \in A$$

$$\Leftrightarrow f(a) = f(b) \Rightarrow a = b \text{ for all } a, b \in A$$

Algorithm

- (i) Take two arbitrary elements x, y (say) in the domain of f .
- (ii) Put $f(x) = f(y)$
- (iii) Solve $f(x) = f(y)$. If $f(x) = f(y)$ gives $x = y$ only, then $f : A \rightarrow B$ is a one-one function (or an injection). Otherwise not.

- NOTE** (i) Let $f : A \rightarrow B$ and let $x, y \in A$. Then, $x = y \Rightarrow f(x) = f(y)$ is always true from the definition. But, $f(x) = f(y) \Rightarrow x = y$ is true only when f is one-one.
- (ii) If A and B are two sets having m and n elements respectively such that $m \leq n$, then total number of one-one functions from A to B is ${}^n C_m \times m!$.

MANY-ONE FUNCTION

A function $f : A \rightarrow B$ is said to be a many-one function if two or more elements of set A have the same image in B .

Thus, $f : A \rightarrow B$ is a many-one function if there exist $x, y \in A$ such that $x \neq y$ but $f(x) = f(y)$.

NOTE In other words, $f : A \rightarrow B$ is many-one function if it is not a one-one function.

ONTO FUNCTION (SURJECTION)

A function $f : A \rightarrow B$ is said to be an onto function or a surjection if every element of B is the f -image of some element of A i.e., if $f(A) = B$ or range of f is the co-domain of f .

Thus, $f : A \rightarrow B$ is a surjection iff for each $b \in B$, there exists $a \in A$ such that $f(a) = b$.

INTO FUNCTION. A function $f : A \rightarrow B$ is an into function if there exists an element in B having no pre-image in A .

In other words, $f : A \rightarrow B$ is an into function if it is not an onto function.

Algorithm

Let $f : A \rightarrow B$ be the given function.

- (i) Choose an arbitrary element y in B .
- (ii) Put $f(x) = y$
- (iii) Solve the equation $f(x) = y$ for x and obtain x in terms of y . Let $x = g(y)$.
- (iv) If for all values of $y \in B$, the values of x obtained from $x = g(y)$ are in A , then f is onto. If there are some $y \in B$ for which x , given by $x = g(y)$, is not in A . Then, f is not onto.

BIJECTION (ONE-ONE ONTO FUNCTION)

A function $f : A \rightarrow B$ is a bijection if it is one-one as well as onto. In other words, a function $f : A \rightarrow B$ is a bijection, if

- (i) it is one-one i.e. $f(x) = f(y) \Rightarrow x = y$ for all $x, y \in A$.
- (ii) it is onto i.e. for all $y \in B$, there exists $x \in A$ such that $f(x) = y$.

REMARK If A and B are two finite sets and $f : A \rightarrow B$ is a function, then

- (i) f is an injection $\Rightarrow n(A) \leq n(B)$
- (ii) f is an surjection $\Rightarrow n(B) \leq n(A)$
- (iii) f is an bijection $\Rightarrow n(A) = n(B)$.

HOMOGENEOUS FUNCTIONS

A function is said to be homogeneous with respect to any set of variables when each of its terms is of the same degree with respect to those variables.

For example $5x^2 + 3y^2 - xy$ is homogeneous in x & y .

i.e. $f(x, y)$ is a homogeneous function iff

$$f(tx, ty) = t^n f(x, y)$$

or $f(x, y) = x^n g\left(\frac{y}{x}\right) = y^n h\left(\frac{x}{y}\right)$, where n is the degree of homogeneity

e.g. $f(x, y) = \frac{x - y \cos x}{y \sin x}$ is not a homogeneous function and

e.g. $f(x, y) = \frac{x}{y} \ln \frac{y}{x} + \frac{y}{x} \ln \frac{x}{y}$; $\sqrt{x^2 - y^2} + x$; $x + y \cos \frac{y}{x}$ are homogeneous functions of degree one.

BOUNDED FUNCTION

A function is said to be bounded if $|f(x)| \leq M$, where M is a finite quantity.

e.g. $f(x) = \sin x$ is bounded in $[-1, 1]$

IMPLICIT & EXPLICIT FUNCTION

A function defined by an equation not solved for the dependent variable is called an IMPLICIT FUNCTION. For eg. the equation $x^3 + y^3 = 1$ defines y as an implicit function. If y has been expressed in terms of x alone then it is called an EXPLICIT FUNCTION.

ODD & EVEN FUNCTION

A function $f(x)$ defined on the symmetric interval $(-a, a)$

Iff $f(-x) = f(x)$ for all x in the domain of ' f ' then f is said to be an even function.

e.g. $f(x) = \cos x$; $g(x) = x^2 + 3$

Iff $f(-x) = -f(x)$ for all x in the domain of ' f ' then f is said to be an odd function.

e.g. $f(x) = \sin x$; $g(x) = x^3 + x$.

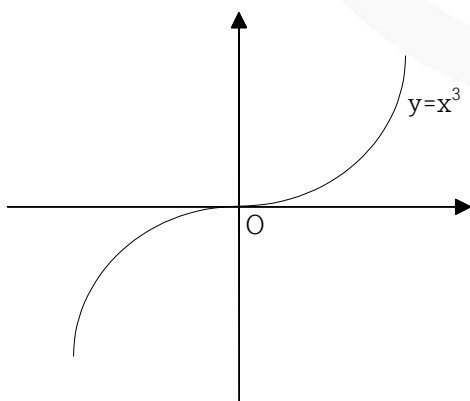

Odd function (Symmetric about origin)

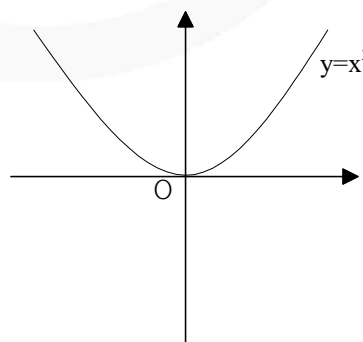

Even function (Symmetric about y-axis)

- NOTE**
- (a) $f(x) - f(-x) = 0 \Rightarrow f(x)$ is even & $f(x) + f(-x) = 0 \Rightarrow f(x)$ is odd.
 - (b) A function may neither be odd nor even.
 - (c) Inverse of an even function is not defined and an even function can not be strictly monotonic
 - (d) Every even function is symmetric about the y -axis & every odd function is symmetric about the origin.
 - (e) Every function can be expressed as the sum of an even & an odd function.

$$\text{e.g. } f(x) = \underbrace{\frac{f(x) + f(-x)}{2}}_{\text{EVEN}} + \underbrace{\frac{f(x) - f(-x)}{2}}_{\text{ODD}} \qquad 2^x = \underbrace{\frac{2^x + 2^{-x}}{2}}_{\text{EVEN}} + \underbrace{\frac{2^x - 2^{-x}}{2}}_{\text{ODD}}$$

- (f) The only function which is defined on the entire number line & is even and odd at the same time is $f(x) = 0$. Any non zero constant is even.
- (g) If f and g both are even or both are odd then the function $f.g$ will be even but if any one of them is odd then $f.g$ will be odd.

$f(x)$	$g(x)$	$f(x) + g(x)$	$f(x) - g(x)$	$f(x).g(x)$	$f(x) / g(x)$	$(g \circ f)(x)$	$(f \circ g)(x)$
odd	odd	odd	odd	even	even	odd	odd
even	even	even	even	even	even	even	even
odd	even	neither odd nor even	neither odd nor even	odd	odd	even	even
even	odd	neither odd nor even	neither odd nor even	odd	odd	even	even

PERIODIC FUNCTION

A function $f(x)$ is called periodic if there exists a positive number $T(T > 0)$ called the period of the function such that $f(x + T) = f(x)$, for all values of x within the domain of x .
e.g. The function $\sin x$ & $\cos x$ both are periodic over 2π & $\tan x$ is periodic over π .

Graphically :

If the graph repeats at fixed interval then function is said to be periodic and its period is the width of that interval.

PROPERTIES OF PERIODIC FUNCTION

- (i) $f(T) = f(0) = f(-T)$, where ' T ' is the period.
- (ii) Inverse of a periodic function does not exist.
- (iii) Every constant function is always periodic, with no fundamental period.
- (iv) If $f(x)$ has a period p , then $\frac{1}{f(x)}$ and $\sqrt{f(x)}$ also has a period p .
- (v) if $f(x)$ has a period T then $f(ax + b)$ has a period $\frac{T}{|a|}$.

- (vi) If $f(x)$ has a period T & $g(x)$ also has a period T then it does not mean that $f(x) + g(x)$ must have a period T . e.g. $f(x) = |\sin x| + |\cos x|$; $\sin^4 x + \cos^4 x$ has fundamental period equal to $\frac{\pi}{2}$.
- (vii) If $f(x)$ and $g(x)$ are periodic then $f(x) + g(x)$ need not be periodic.
e.g. $f(x) = \cos x$ and $g(x) = \{x\}$

04. Composition of Uniformly Defined Functions

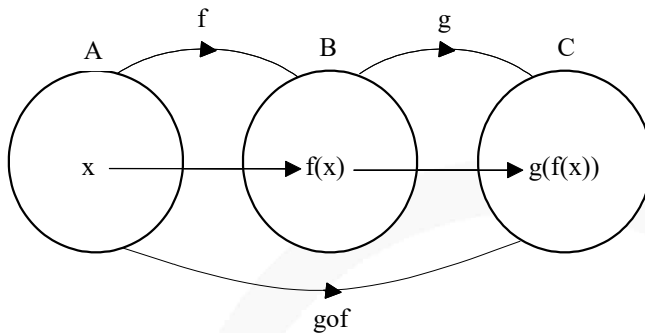

Definition:

Let $f : A \rightarrow B$ and $g : B \rightarrow C$ be two functions. Then a function $gof : A \rightarrow C$ defined by

$$(gof)(x) = g(f(x)), \text{ for all } x \in A$$

is called the composition of f and g .

- NOTE** (i) It is evident from the definition that gof is defined only if for each $x \in A$, $f(x)$ is an element of B so that we can take its g -image. Hence, for the composition gof to exist, the range of f must be subset of the domain of g .
- (ii) It should be noted that gof exists iff the range of f is a subset of domain of g . Similarly, fog exists if range of g is a subset of domain of f .

PROPERTIES OF COMPOSITION OF FUNCTIONS

RESULT 1 The composition of functions is not commutative i.e. $fog \neq gof$.

RESULT 2 The composition of functions is associative i.e. if f, g, h are three functions such that $(fog)oh$ and $fo(goh)$ exist, then

$$(fog)oh = fo(goh)$$

RESULT 3 The composition of two bijections is a bijection i.e. if f and g are two bijections, then gof is also a bijection.

RESULT 4 Let $f : A \rightarrow B$. Then, $foI_A = I_Bof = f$ i.e. the composition of any function with the identity function is the function itself.

RESULT 5 Let $f : A \rightarrow B, g : B \rightarrow A$ be two functions such that $gof = I_A$. Then, f is an injection and g is a surjection.

RESULT 6 Let $f : A \rightarrow B$ and $g : B \rightarrow A$ be two function such that $f \circ g = I_B$. Then, f is a surjection and g is an injection.

RESULT 7 Let $f : A \rightarrow B$ and $g : B \rightarrow A$ be two functions. Then,

- (i) $g \circ f : A \rightarrow A$ is into $\Rightarrow g : B \rightarrow A$ is onto
- (ii) $g \circ f : A \rightarrow A$ is one-one $\Rightarrow f : A \rightarrow B$ is one-one
- (iii) $g \circ f : A \rightarrow A$ is onto and $\Rightarrow g : B \rightarrow A$ is one-one $\Rightarrow f : A \rightarrow B$ is onto
- (iv) $g \circ f : A \rightarrow A$ is one-one and $\Rightarrow f : A \rightarrow B$ is onto $\Rightarrow g : B \rightarrow A$ is one-one.

05. Composition of Non-Uniformly Defined Functions

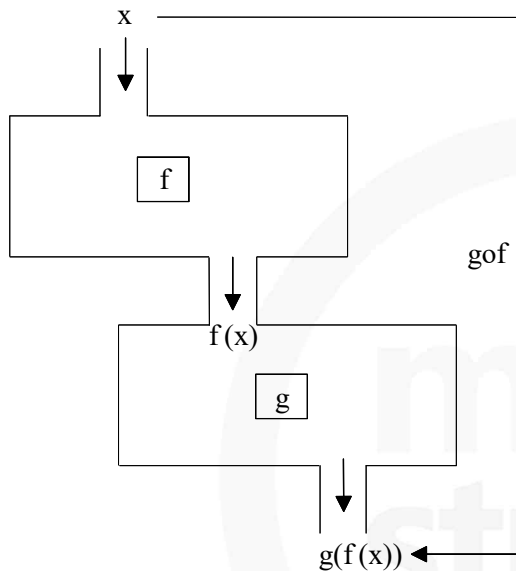

Piecewise or non-uniformly defined functions: Those functions whose domain is divided into two or more than two parts so that the function has different analytical formulae in different parts of its domain are called piecewise or non-uniformly defined functions. Also, a piecewise defined function is composed of branches of two or more functions.

Method: The method to find the composition of two non-uniformly defined functions is as follows-

Consider the functions as defined below

$$f(x) = \begin{cases} 2x-1; & 0 \leq x < 2 \\ x^2+1; & 2 \leq x \leq 4 \end{cases} \quad \& \quad g(x) = \begin{cases} x+1; & -1 \leq x < 1 \\ 2x; & 1 \leq x \leq 3 \end{cases}$$

Let us find the composite function $f \circ g(x)$. The following steps are involved.

STEP 1: Replace $g(x)$ in the place of x in the definition of $f(x)$.

$$\text{i.e., } f(g(x)) = \begin{cases} 2g(x)-1; & 0 \leq g(x) < 2 \\ g(x)^2+1; & 2 \leq g(x) \leq 4 \end{cases}$$

STEP 2: Apply the definition of $g(x)$ in the above step (1).

$$\Rightarrow f(g(x)) = \begin{cases} 2(x+1) - 1; & -1 \leq x < 1 & \& \quad 0 \leq x+1 < 2 \\ 2(2x) - 1; & 1 \leq x \leq 3 & \& \quad 0 \leq 2x < 2 \\ (x+1)^2 + 1; & -1 \leq x < 1 & \& \quad 2 \leq x+1 \leq 4 \\ (2x)^2 + 1; & 1 \leq x \leq 3 & \& \quad 2 \leq 2x \leq 4 \end{cases}$$

STEP 3: Take the intersection of domain and find the final definition.

$$\text{i.e., } f(g(x)) = \begin{cases} 2(x+1) - 1; & -1 \leq x < 1 \\ 2(2x) - 1; & x \in \{ \} \\ (x+1)^2 + 1; & x \in \{ \} \\ (2x)^2 + 1; & 1 \leq x \leq 2 \end{cases}$$

$$\Rightarrow f(g(x)) = \begin{cases} 2x+1; & -1 \leq x < 1 \\ 4x^2+1; & 1 \leq x \leq 2 \end{cases}$$

Thus, the domain of composite function $f \circ g(x)$ is $[-1, 2]$

06. Composition of Real Functions

Definition:

Let $f : D_1 \rightarrow R$ and $g : D_2 \rightarrow R$ be two real functions. Then,

$$g \circ f : X = \{x \in D_1 : f(x) \in D_2\} \rightarrow R$$

and,

$$f \circ g : Y = \{x \in D_2 : g(x) \in D_1\} \rightarrow R$$

are defined as

$$g \circ f(x) : g(f(x)) \text{ for all } x \in X \text{ and } f \circ g(x) = f(g(x)) \text{ for all } x \in Y.$$

- REMARK**
- (1) If $\text{Range}(f) \subseteq \text{Domain}(g)$, then $g \circ f : D_1 \rightarrow R$ and if $\text{Range}(g) \subseteq \text{Domain}(f)$, then $f \circ g : D_2 \rightarrow R$.
 - (2) For any two real functions f and g , it may be possible that $g \circ f$ exists but $f \circ g$ does not. In some cases, even if both exist, they may not be equal.
 - (3) If $\text{Range}(f) \cap \text{Domain}(g) = \phi$, then $g \circ f$ does not exist. In other words, $g \circ f$ exists if $\text{Range}(f) \cap \text{Domain}(g) \neq \phi$.
Similarly, $f \circ g$ exists if $\text{Range}(g) \cap \text{Domain}(f) \neq \phi$.
 - (4) If f and g are bijections, then $f \circ g$ and $g \circ f$ both are bijections.
 - (5) If $f : R \rightarrow R$ and $g : R \rightarrow R$ to real functions, then $f \circ g$ and $g \circ f$ both exist.

07. Inverse of An Element

Let A and B be two sets and let $f: A \rightarrow B$ be a mapping. If $a \in A$ is associated to $b \in B$ under the function f , then ' b ' is called the f image of ' a ' and we write it as $b = f(a)$. We also say that ' a ' is the pre-image or inverse element of ' b ' under f and we write $a = f^{-1}(b)$.

NOTE  The inverse of an element under a function may consist of a single element, two or more elements or no element depending on whether function is injective or many-one; onto or into.

If f is represented by Figure, then we find that

$$\begin{aligned} f^{-1}(b_1) &= \phi, f^{-1}(b_2) = a_4, \\ f^{-1}(b_3) &= \{a_1, a_2\}, f^{-1}(b_4) = a_3, \\ f^{-1}(b_5) &= \{a_5, a_6\}, f^{-1}(b_6) = \phi \\ \text{and, } f^{-1}(b_7) &= \phi \end{aligned}$$

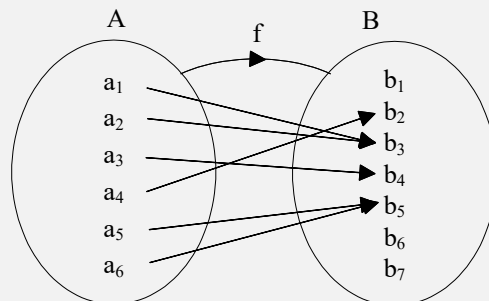

08. Inverse of A Function

Definition:

Let $f: A \rightarrow B$ be a bijection. Then a function $g: B \rightarrow A$ which associates each element $y \in B$ to a unique element $x \in A$ such that $f(x) = y$ is called the inverse of f .

$$\text{i.e., } f(x) = y \Leftrightarrow g(y) = x$$

The inverse of f is generally denoted by f^{-1}

Thus, if $f: A \rightarrow B$ is a bijection, then $f^{-1}: B \rightarrow A$ is such that

$$f(x) = y \Leftrightarrow f^{-1}(y) = x$$

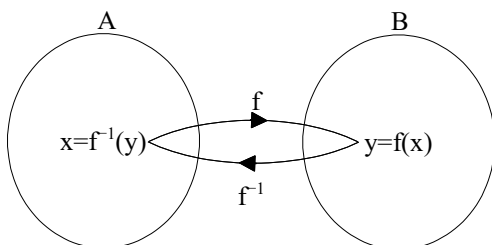

Algorithm

Let $f: A \rightarrow B$ be a bijection. To find the inverse of f we follow the following steps:

STEP I Put $f(x) = y$, where $y \in B$ and $x \in A$.

STEP II Solve $f(x) = y$ to obtain x in terms of y .

STEP III In the relation obtained in step II replace x by $f^{-1}(y)$ to obtain the required inverse of f .

09. Properties of Inverse of a Function

RESULT 1 The inverse of a bijection is unique.

RESULT 2 The inverse of a bijection is also a bijection.

RESULT 3 If $f: A \rightarrow B$ is a bijection and $g: B \rightarrow A$ is the inverse of f , then $f \circ g = I_B$ and $g \circ f = I_A$, where I_A and I_B are the identity function on the sets A and B respectively.

RESULT 4 If $f: A \rightarrow B$ and $g: B \rightarrow C$ are two bijections, then $g \circ f: A \rightarrow C$ is a bijection and $(g \circ f)^{-1} = f^{-1} \circ g^{-1}$

RESULT 5 If $f: A \rightarrow B$ and $g: B \rightarrow A$ be two functions such that $g \circ f = I_A$ and $f \circ g = I_B$. Then, f and g are bijections and $g = f^{-1}$.

RESULT 6 Let $f: A \rightarrow B$ be an invertible function. Show that the inverse of f^{-1} is f , i.e., $(f^{-1})^{-1} = f$.

REMARK

- (1) Sometimes $f: A \rightarrow B$ is one-one but not onto. In such a case f is not invertible. But, $f: A \rightarrow \text{Range}(f)$ is both one and onto. So, it is invertible and its inverse can be found.
- (2) Result 5 suggests us an alternative method to prove the invertibility of a function. It states that if $f: A \rightarrow B$ and $g: B \rightarrow A$ are two functions such that $g \circ f = I_A$ and $f \circ g = I_B$, then f and g are inverse of each other. Result 5 suggests the following algorithm to find the inverse of an invertible function.

Algorithm

STEP I Obtain the function and check its bijectivity.

STEP II If f is a bijection, then it is invertible.

STEP III Use the formula for $f(x)$ and replace x by $f^{-1}(x)$ in it to obtain the LHS of $f(f^{-1}(x)) = x$.

Solve this equation for $f^{-1}(x)$ to get $f^{-1}(x)$.

10. Permutation and Combinations Problems

NUMBER OF RELATIONS AND FUNCTIONS

Given two finite sets A and B having n and m elements respectively, i.e., $n(A) = n$ and $n(B) = m$.

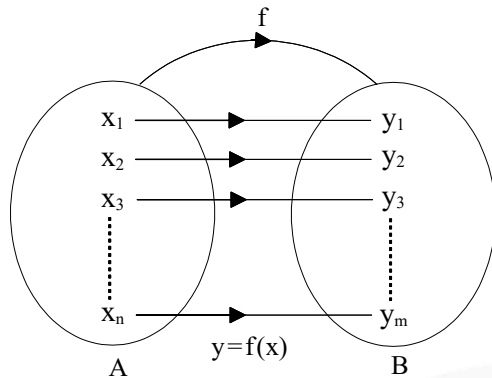

Number of Relations: No. of relations = Number of subsets of $A \times B = 2^{n(A \times B)} = 2^{nm}$

Number of Functions: Since each element of set A can be mapped in m ways

\Rightarrow Number of ways of mapping all n elements of A

$$= \underbrace{(m \times m \times m \times \dots \times m)}_{n \times} \text{ ways} = m^n \text{ ways}$$

Conclusion: $2^{nm} \geq m^n \forall m, n \in \mathbf{N}$

NUMBER OF ONE-ONE FUNCTION (INJECTIVE):

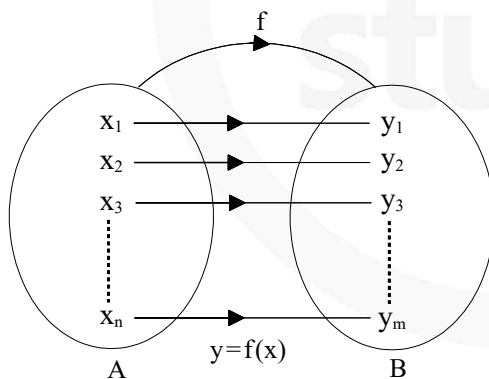

Conclusion: ${}^m P_n \leq m^n$ (total number of functions).

NUMBER OF NON-SURJECTIVE FUNCTIONS (INTO FUNCTIONS)

Number of into functions (N) = Number of ways of distributing n different objects into m distinct boxes so that at least one box is empty.

$$\therefore N = \sum_{r=1}^m {}^m C_r (-1)^{r-1} (m-r)^n$$

NUMBER OF SURJECTIVE FUNCTIONS

Number of surjective functions = Total number of functions – number of into functions.

$$\begin{aligned}
 &= m^n - \sum_{r=1}^m {}^m C_r (-1)^{r-1} (m-r)^n \\
 &= m^n + \sum_{r=1}^m {}^m C_r (-1)^r (m-r)^n \\
 &= \sum_{r=0}^m {}^m C_r (-1)^r (m-r)^n
 \end{aligned}$$

Conclusion: In case when $n(A) = n(B)$, the onto functions will be bijection

Number of onto functions = Number of one-one functions

$$= \sum_{r=0}^n {}^n C_r (-1)^r (n-r)^n = n!$$

REMARK

- (1) If $n(X) < n(Y)$, then after mapping different elements of X to different elements of Y , we are left with at least one element of Y which is not related with any element of X , and hence, there will be no onto function from X to Y , i.e., all the functions from X to Y will be into.
- (2) If $n(X) > n(Y)$, then no injective functions can be formed from X to Y as in this case at least one element of Y has to be related to more than one element of X .
- (3) If f from X to Y is a bijective functions, then $n(X) = n(Y)$

Example

A function $f: A \rightarrow B$, such that set “ A ” and “ B ” contain four elements each then find

- (i) Total number of functions
- (ii) Number of one-one functions
- (iii) Number of many one functions
- (iv) Number of onto functions
- (v) Number of into functions

Sol.

- (i) 1st element of A can have its image in 4 ways. Similarly, IInd, IIIrd and IVth can have 4 options for their image each. Hence number of functions = 4^4
- (ii) 4 different elements can be matched in $4!$ ways
- (iii) Number of many-one functions
= Total number of functions – number of one-one functions
= $4^4 - 4!$
- (iv) Since 4 elements in B are given hence each should be image of atleast one.
So number of onto functions = $4!$
- (v) Number of into functions = $4^4 - 4!$

11. Functional Equations

Example

If $f(0) = 1, f(1) = 2$ & $f(x) = \frac{1}{2}[f(x+1)+f(x+2)]$, find the value of $f(5)$.

Sol.

$$\begin{aligned} f(x+2) &= 2f(x) - f(x+1) \\ \text{thus } f(0+2) &= f(2) = 2f(0) - f(1) = 2(1) - 2 = 0 \\ f(3) &= 2f(1) - f(2) = 2(2) - 0 = 4 \\ f(4) &= 2f(2) - f(3) = 0 - 4 = -4 \\ f(5) &= 2f(3) - f(4) = 2(4) - (-4) = 12 \end{aligned}$$

12. Binary Operation

DEFINITION

A binary operation $*$ on a set A is a function from set $A \times A$ to A itself. Thus, $*$ associates each pair $(a_1, a_2) \in A \times A$ to a unique element $(a_1 * a_2)$ of A . Thus, domain of a binary operation defined on set A is $A \times A$ and co-domain is A . Range is subset of A .

For example,

Let $A = \{-1, 0, 1\}$ and $*$ is a function defined as $*$ $(a_1, a_2) = a_1 \cdot a_2; a_1, a_2 \in A$

Now we observe,

$$\begin{aligned} * (-1, -1) &= (-1) \cdot (-1) = 1 \in A; \\ * (-1, 0) &= (-1) \cdot (0) = 0 \in A; \\ * (-1, 1) &= (-1) \cdot (1) = -1 \in A; \\ * (1, 1) &= (1) \cdot (1) = 1 \in A; \\ * (1, 0) &= (1) \cdot (0) = 0 \in A; \\ * (0, 0) &= (0) \cdot (0) = 0 \in A; \end{aligned}$$

Thus, $*$ operated to every pair $(a_1, a_2) \in A \times A$ gives us a unique element of A .

Hence, the function $*$ defined in the above example is a binary operation on set A .

PROPERTIES OF BINARY OPERATION $*$ ON A SET A

- (i) **Closure Property:** Since binary operation $*$ on a set A is a function from $A \times A$ to A , it obeys closure law, i.e., $a * b \in A \forall a, b \in A$. Also we say that A is closed with respect to binary operation $*$.
- (ii) **Associativity:** Binary operation $*$ on a set A is said to be associative, if $a * (b * c) = (a * b) * c \forall a, b, c \in A$.
- (iii) **Commutativity:** Binary operation $*$ on a set A is said to be commutative if $a * b = b * a \forall a, b \in A$.
- (iv) **Existence of Identity:** An element $e \in A$ is said to be an identity element of set A with respect to binary operation $*$ if $a * e = e * a = a \forall a \in A$. For example, '+' is a binary operation on set of integer \mathbb{Z} . Also $0 \in \mathbb{Z}$ and $x + 0 = 0 + x = x \forall x \in \mathbb{Z} \Rightarrow 0$ is an identity element of set of integers \mathbb{Z} with respect to binary operation '+' (addition). Also 0 is called additive identity of set of integers.

- (v) **Existence of Inverse:** An element $b \in A$ is said to be inverse of element $a \in A$ with respect to binary operation $*$ if $a * b = e = b * a$; where e is the identity element of A with respect to binary operation $*$. And we denote $b = a^{-1}$.

- REMARK**
1. If a binary operation $*$ on set A is associative and identity element exists in A and every element of A is invertible, then A is said to be a Group with respect to binary operation $*$.
 2. In addition to properties given in remark (1) if $*$ is commutative, then set A is said to be an Abelian Group with respect to binary operation $*$.
 3. If $b = a^{-1}$, then $a = b^{-1}$.
 4. Identity element if exists is unique.
 5. Inverse of an element if exists is unique provided $*$ is associative.
 6. Number of binary operations that can be defined on a set A containing n number of elements is $(n)^{2n}$.

13. Some Graphical Transformation

Consider the graph $y = f(x)$ shown alongside.

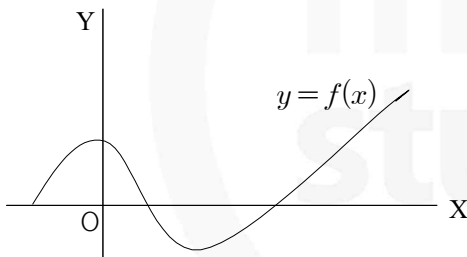

- (i) Graph of $y - \beta = f(x - \alpha)$ is drawn by shifting the origin to (α, β) & then translating the graph of $y = f(x)$ w.r.t. new axes

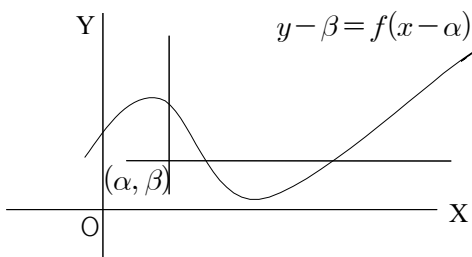

- (ii) The graph of $y = -f(x)$ is the mirror image of $f(x)$ in X -axis.

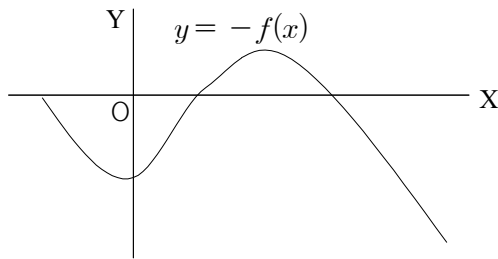

- (iii) $y = |f(x)|$ is mirror image of negative portion of $y = f(x)$ in X -axis.

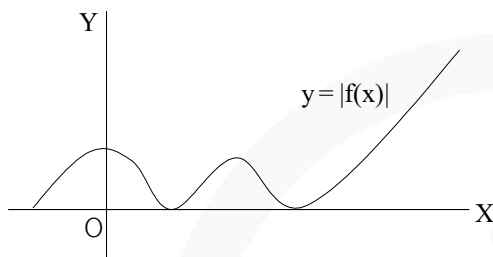

- (iv) $y = f(|x|)$ is drawn by taking the mirror image of positive x -axis graph in y -axis.

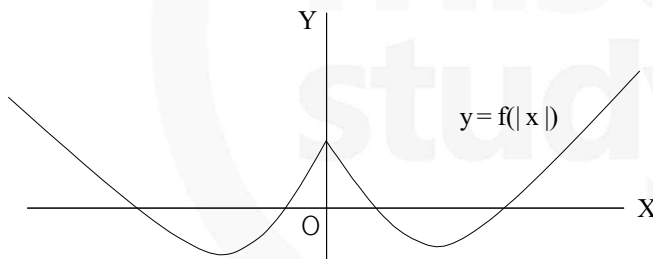

- (v) The graph of $|y| = f(x)$ is drawn by deleting those portions of the graph $y = f(x)$ which lie below the X -axis and then taking the mirror image of the remaining portion in the X -axis, as shown alongside.

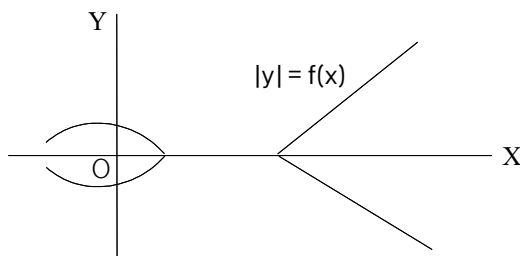

(vi) $x = f(y)$ is drawn by taking mirror image of $y = f(x)$ in the line $y = x$.

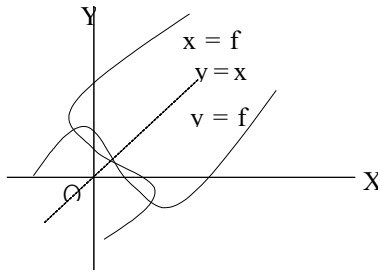

(vii) $y = f(-x)$ is drawn by taking the mirror image of $y = f(x)$ in Y -axis,

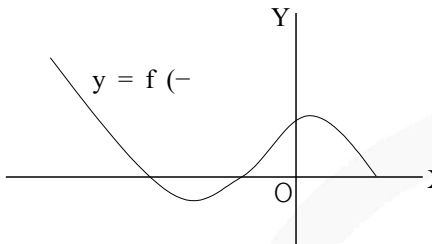

14. Transformation of Graphs

★ **GRAPH OF $y = f(x) + k$:**

Graph of $y = f(x) + k$ can be obtained by translating graph of $f(x)$ by $|k|$ unit along y -axis in the direction same as sign of k , i.e., upward when $k > 0$ and downward when $k < 0$.

REASON:

This is because each out put of the function is added by k . Therefore, each point of graph shifts vertically by k unit.

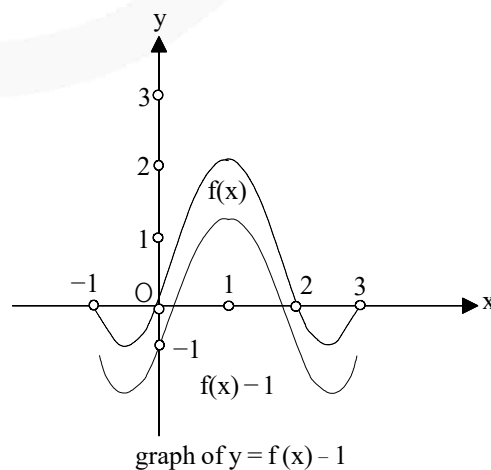
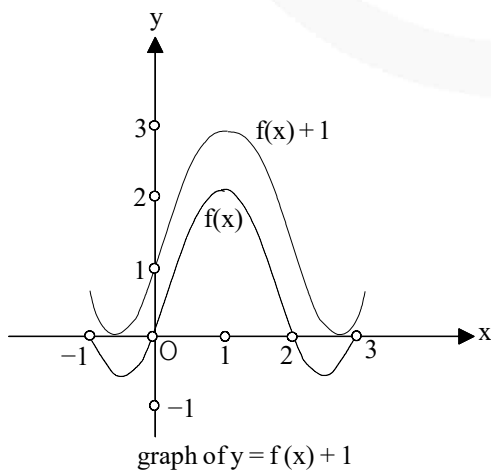

★ **GRAPH OF $y = f(x + k)$:**

Graph of $y = f(x + k)$ can be obtained by translating graph of $y = f(x)$ by $|k|$ units in the direction opposite to the sign of k along x -axis. That is, a addition and subtraction to independent variable leads to horizontal shift.

REASON:

As because each output $f(x)$ of the original function is obtained by the transformed function $f(x + k)$ at the input $x - k$.

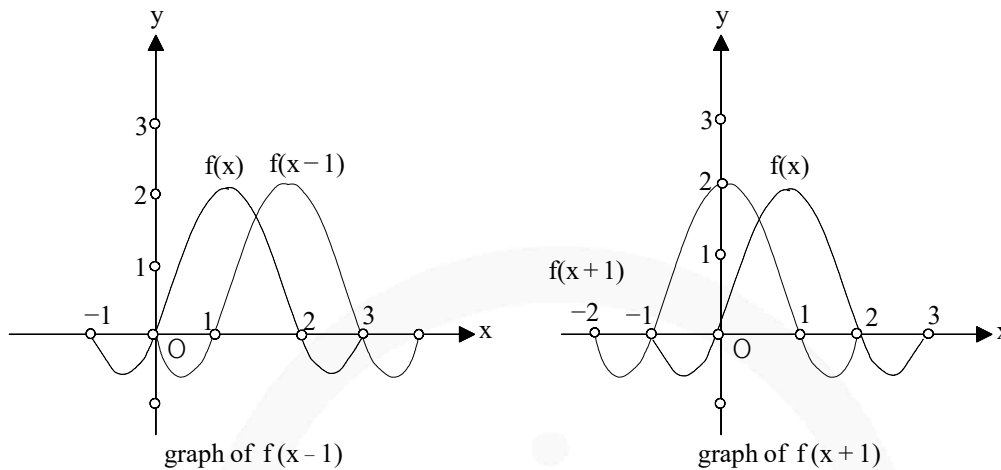

★ **GRAPH OF $y = k(f(x))$:**

Graph of $y = k(f(x))$ can be obtained by vertically stretching or contracting the graph of $f(x)$ depending on the value of k .

REASON:

It is because each output of the obtained function becomes k times that of the original function. Hence, due to this transformation no stretching/compression is produce along x -axis.

CASE I: When $0 < |k| < 1$

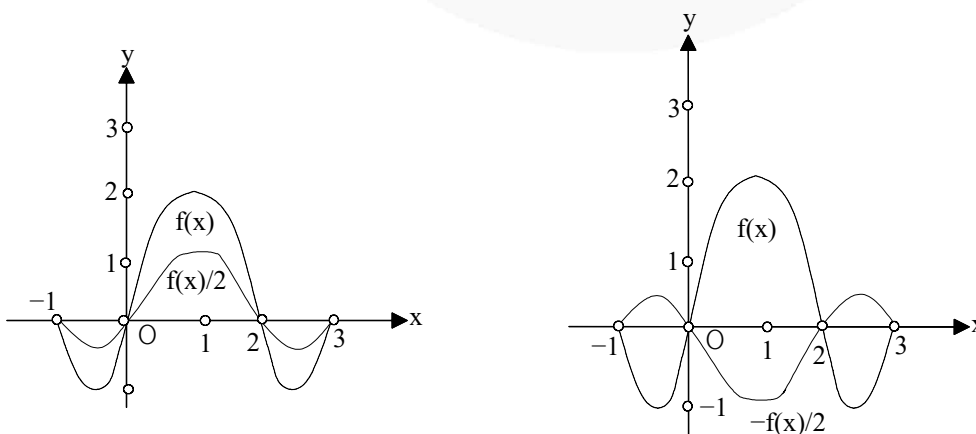

CASE II: When $|k| > 1$

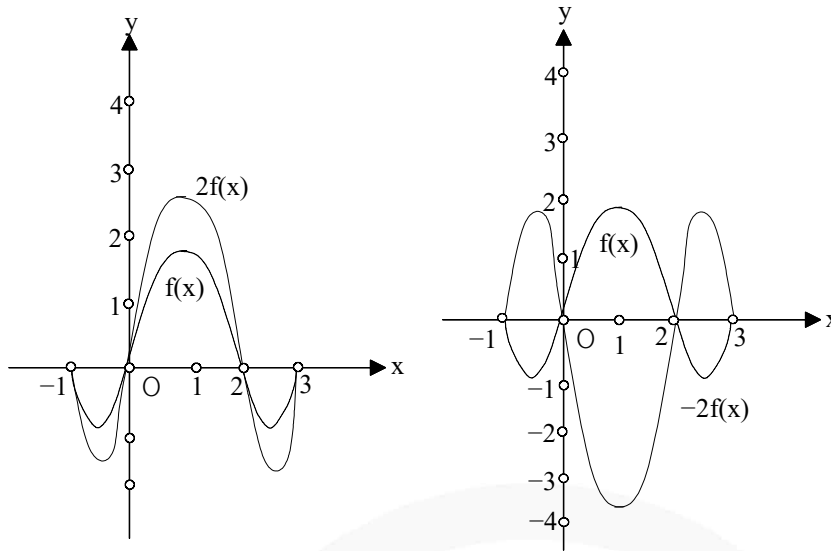

★ **GRAPH OF $y = f(kx)$:**

Graph of $y = f(kx)$ can be obtained by compressing or stretching the graph of $y = f(x)$ along x -axis towards y -axis or away from y -axis depending on the value of k as described below.

CASE I:

When $|k| > 1$, compressing the graph of $f(x)$ horizontally towards y -axis.

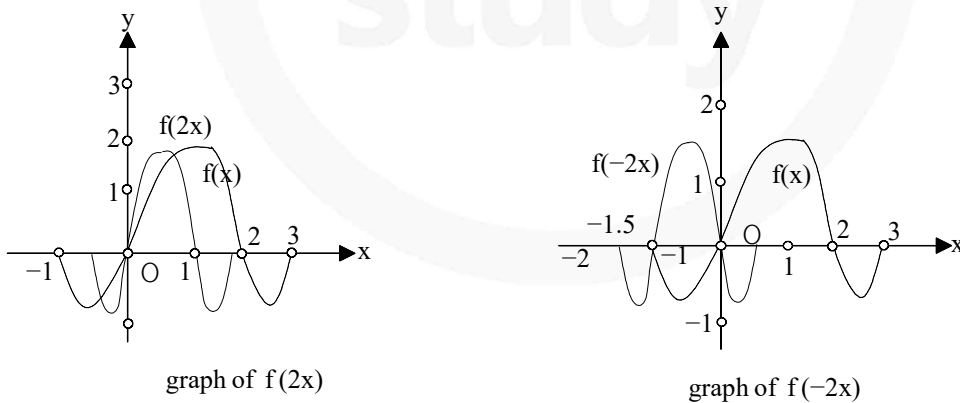

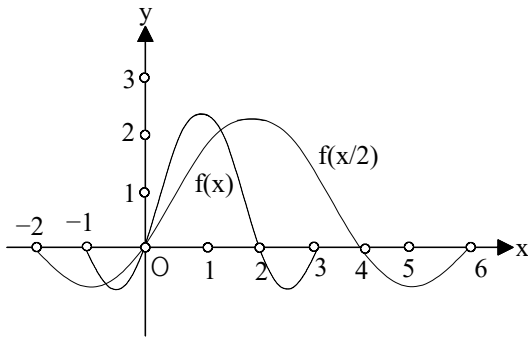

graph of $f(x/2)$

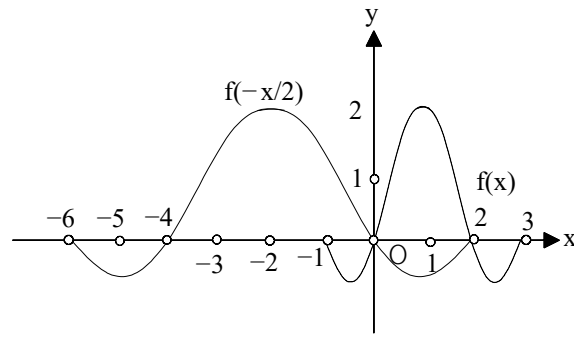

graph of $f(-x/2)$

★ **GRAPH OF $y = |f(x)|$:**

Graph of $y = |f(x)|$ can be obtained by reflecting the portion of the graph of $f(x)$ laying below x -axis on x -axis as a mirror and keeping the portion of graph above x -axis as it is.

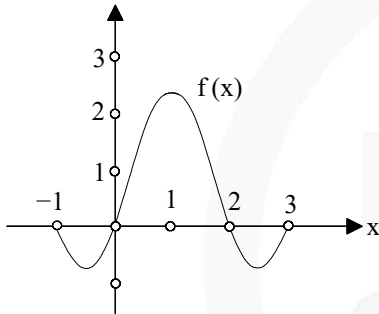

graph of $f(x)$

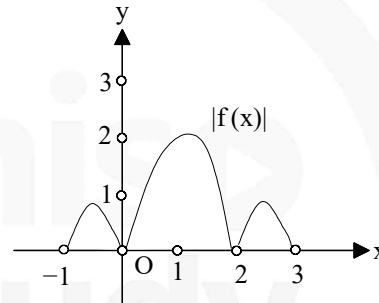

graph of $|f(x)|$

★ **GRAPH OF $y = f(|x|)$:**

Graph of $y = f(|x|)$ can be obtained by keeping the portion of graph of $f(x)$ on right side of y -axis and replacing the portion of the graph of $y = f(x)$ on left side of y -axis by the reflection of right graph on y -axis.

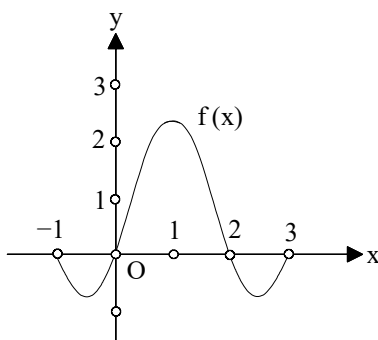

graph of $f(x)$

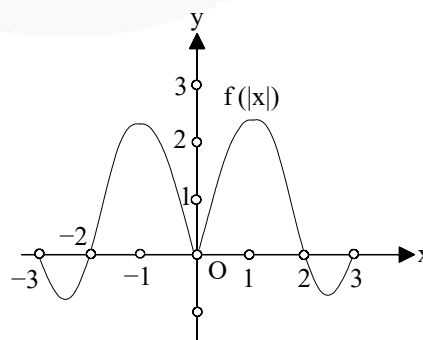

graph of $f(|x|)$

★ **GRAPH OF $y = f(|x|)$:**

Graph of $y = f(|x|)$ can be obtained by keeping the portion of graph of $f(x)$ on right side of y -axis and replacing the portion of the graph of $y = f(x)$ on left side of y -axis by the reflection of right graph on y -axis.

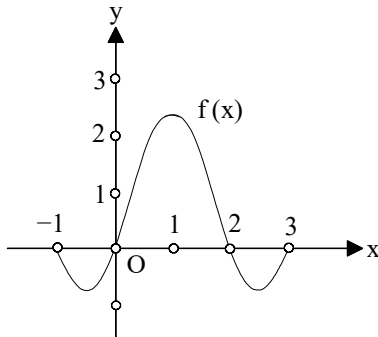

graph of $f(x)$

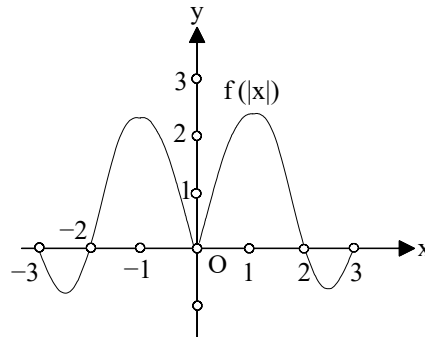

graph of $f(|x|)$

★ **GRAPH OF $y = |f(x)|$ can be obtained in two steps :**

Step 1: Using graph of $y = f(x)$, draw the graph of $f|x|$.

Step 2: Using graph of $y = f|x|$, draw the graph of $y = |f|x||$.

JEE Main Pattern Exercise (1)

- Q1. The function $f: R \rightarrow \left[-\frac{1}{2}, \frac{1}{2}\right]$ defined as $f(x) = \frac{x}{1+x^2}$ is-
- invertible
 - injective but not surjective
 - surjective but not injective
 - neither injective nor surjective
- Q2. If $f_k(x) = 1/k(\sin^k x + \cos^k x)$, where $x \in R$ and $k \geq 1$, then $f_4(x) - f_6(x)$ is equal to-
- 1/6
 - 1/3
 - 1/4
 - 1/12
- Q3. Which of the following relations on R is an equivalence relation?
- $aR_1 b \Leftrightarrow |a| = |b|$
 - $aR_2 b \Leftrightarrow a \geq b$
 - $aR_3 b \Leftrightarrow a$ divides b
 - $aR_4 b \Leftrightarrow a < b$
- Q4. Let $E = \{1, 2, 3, 4\}$ and $F = \{1, 2\}$. Then, the number of onto functions from E to F is-
- 14
 - 16
 - 12
 - 8
- Q5. If $g\{f(x)\} = |\sin x|$ and $f\{g(x)\} = (\sin \sqrt{x})^2$, then
- $f(x) = \sin^2 x, g(x) = \sqrt{x}$
 - $f(x) = \sin x, g(x) = |x|$
 - $f(x) = x^2, g(x) = \sin \sqrt{x}$
 - f and g cannot be determined
- Q6. If S is defined on R by $(x, y) \in S \Leftrightarrow xy \geq 0$. Then S is-
- an equivalence relation
 - reflexive only
 - symmetric only
 - transitive only
- Q7. Let $f(x) = \frac{\alpha x}{x+1}, x \neq -1$. Then, for what value of α is $f[f(x)] = x$?
- $\sqrt{2}$
 - $-\sqrt{2}$
 - 1
 - 1

- Q8. If $f(x) = \cos(\log x)$, then $f(x) \cdot f(y) - \frac{1}{2} \left[f\left(\frac{x}{y}\right) + f(xy) \right]$ has the value
- (a) -1
 - (b) $\frac{1}{2}$
 - (c) -2
 - (d) None of these
- Q9. Let S be the set of all real numbers & let R be a relation on S defined by $aRb \Leftrightarrow |a-b| \leq 1$. Then R is-
- (a) Reflexive & Symmetric but not Transitive
 - (b) Reflexive & Transitive but not Symmetric
 - (c) Symmetric & Transitive but not Reflexive
 - (d) an equivalence relation
- Q10. If $f(x) = \sin x + \cos x$, $g(x) = x^2 - 1$, then $g\{f(x)\}$ is invertible in the domain
- (a) $\left[0, \frac{\pi}{2}\right]$
 - (b) $\left[-\frac{\pi}{4}, \frac{\pi}{4}\right]$
 - (c) $\left[-\frac{\pi}{2}, \frac{\pi}{2}\right]$
 - (d) $[0, \pi]$



Answer & Solution

ANSWER

Q1	Q2	Q3	Q4	Q5
(c)	(b)	(d)	(a)	(c)
Q6	Q7	Q8	Q9	Q10
(a)	(d)	(a)	(c)	(d)

miso
study

JEE Advanced Pattern Exercise (1)

Q1. If $y = f(x) = \frac{x+2}{x-1}$, then-

- (a) $x = f(y)$
- (b) $f(1) = 3$
- (c) y increases with x for $x < 1$
- (d) f is a rational function of x

Q2. Which of the following functions is periodic?

- (a) $f(x) = x - [x]$, where $[x]$ denotes the greatest integer less than or equal to the real number x
- (b) $f(x) = \sin(1/x)$ for $x \neq 0, f(0) = 0$
- (c) $f(x) = x \cos x$
- (d) None of the above

Q3. Given the relation on $R = \{(a,b), (b,c)\}$ in the set $A = \{a,b,c\}$. Then, the minimum number of ordered pairs which added to R make it an equivalence relation is-

- (a) 5
- (b) 6
- (c) 7
- (d) 8

Q4. If $f: [1, \infty) \rightarrow [2, \infty)$ is given by $f(x) = x + \frac{1}{x}$, then $f^{-1}(x)$ equal.

- (a) $\frac{x + \sqrt{x^2 - 4}}{2}$
- (b) $\frac{x}{1+x^2}$
- (c) $\frac{x - \sqrt{x^2 - 4}}{2}$
- (d) $1 + \sqrt{x^2 - 4}$

Q5. Let $f(x) = \sin\left[\frac{\pi}{6} \sin\left(\frac{\pi}{2} \sin x\right)\right]$ for all $x \in R$ and $g(x) = \frac{\pi}{2} \sin x$ for all $x \in R$. Let $(f \circ g)(x)$ denotes $f\{g(x)\}$ and $(g \circ f)(x)$ denotes $g\{f(x)\}$. Then, which of the following is/are true?

- (a) Range of f is $\left[-\frac{1}{2}, \frac{1}{2}\right]$
- (b) Range of $f \circ g$ is $\left[-\frac{1}{2}, \frac{1}{2}\right]$
- (c) $\lim_{x \rightarrow 0} \frac{f(x)}{g(x)} = \frac{\pi}{6}$
- (d) There is an $x \in R$ such that $(g \circ f)(x) = 1$

Q6. Which of the following relations defined on Z is not an equivalence relation-

- (a) $(x,y) \in S \Leftrightarrow x \geq y$
- (b) $(x,y) \in S \Leftrightarrow x = y$
- (c) $(x,y) \in S \Leftrightarrow x - y$ is a multiple of 3
- (d) $(x,y) \in S \Leftrightarrow |x - y|$ is even

03 Relations & Functions

- Q7. If the function $f: [1, \infty) \rightarrow [1, \infty)$ is defined by $f(x) = 2^{x(x-1)}$, then $f^{-1}(x)$ is-
- (a) $\left(\frac{1}{2}\right)^{x(x-1)}$
 - (b) $\frac{1}{2}(1 + \sqrt{1 + 4 \log_2 x})$
 - (c) $\frac{1}{2}(1 - \sqrt{1 + 4 \log_2 x})$
 - (d) not defined
- Q8. Let $a, b, c \in \mathbb{R}$. If $f(x) = ax^2 + bx + c$ be such that $a + b + c = 3$ and $f(x+y) = f(x) + f(y) + xy$, $\forall x, y \in \mathbb{R}$, then $\sum_{n=1}^{10} f(n)$ is equal to-
- (a) 330
 - (b) 165
 - (c) 190
 - (d) 255
- Q9. If $A = \{1, 2, 3\}$ then the no. of equivalence relation containing (1,2) is-
- (a) 1
 - (b) 2
 - (c) 3
 - (d) 8
- Q10. Let f be a one-one function with domain $\{x, y, z\}$ and range $\{1, 2, 3\}$. It is given that exactly one of the following statements is true and the remaining two are false
 $f(x) = 1, f(y) \neq 1, f(z) \neq 2$. Then $f^{-1}(1) =$
- (a) x
 - (b) y
 - (c) z
 - (d) None of these



Answer & Solution

ANSWER

Q1	Q2	Q3	Q4	Q5
(a), (d)	(a)	(a), (c)	(a)	(a), (b), (c)
Q6	Q7	Q8	Q9	Q10
(a)	(b)	(a)	(c)	(b)

miso
study